

Technical Manual



MDT LED Controller

AKD – 0224V.02
AKD – 0324V.02
AKD – 0424V.02
AKD – 0424R.02
AKD – 0424R2.02

Further Documents :

Datasheets :

https://www.mdt.de/EN_Downloads_Datasheets.html

Assembly and Operation Instructions :

https://www.mdt.de/EN_Downloads_Instructions.html

Solution Proposals for MDT products:

https://www.mdt.de/EN_Downloads_Solutions.html

1 Content

1 Content	2
2 Overview	5
2.1 Overview Devices	5
2.2 Usage & Possible applications	6
2.3 Functional description	7
2.4 Structure & Handling	10
2.5 Exemplary circuit diagram	11
2.6 Commissioning.....	12
2.7 Testing function.....	12
2.8 Behaviour of LEDs – MDRC device.....	12
3 Always valid parameters and communication objects	13
3.1 Alarms	13
3.2 Start-up & Operation	13
3.3 Day/Night object & Location settings for Time/Date	14
3.4 Device Selection – MDRC devices	15
3.5 Description of objects (from DB V2.2).....	15
4 Function selection – Single Channels.....	16
4.1 Communication Objects – Default Settings	17
4.2 Reference ETS-Parameter	18
4.2.1 Global Settings	18
4.2.1.1 Channel activation.....	22
4.2.2 Operation / Basic functions	23
4.2.2.1 Switching.....	23
4.2.2.2 Dimming relative.....	23
4.2.2.3 Dimming absolute	23
4.2.3 Switch On/Off delay.....	24
4.2.4 Staircase Light.....	25
4.2.5 Switch On behaviour	27
4.2.6 Dimming Speed.....	29
4.2.7 Dimming Range	30
4.2.8 Specific Dimming Settings.....	31
4.2.8.1 Status output	31
4.2.8.2 Dimming range under minimum value.....	31
4.2.8.3 Switch off channel with relative dimming	32

4.2.9 Central objects.....	32
4.2.10 Block and Force Functions.....	33
4.2.11 Scenes.....	37
4.2.12 Bit Scenes.....	41
4.2.13 Time dependent Dimming.....	43
5 Function selection – Dimming RGB/RGBW LEDs.....	46
5.1 Communication objects – Default settings.....	47
5.2 Color circle representation/ RGBW control.....	48
5.3 Reference ETS-Parameter.....	49
5.3.1 General Settings.....	49
5.3.2 Control via HSV or RGBW.....	52
5.3.3 LED RGB/RGBW Settings.....	54
5.3.3.1 White balance/Teach-In.....	54
5.3.3.2 Status output.....	56
5.3.3.3 Dimming speeds.....	58
5.3.3.4 Switch-on/off behaviour.....	59
5.3.3.5 Switch-on with.../switch-off with.....	60
5.3.3.6 Behaviour after Reset.....	61
5.3.3.7 Staircase light.....	62
5.3.4 RGB/RGBW Block and Force Functions.....	63
5.3.5 LED RGB/RGBW Bit Scenes.....	67
5.3.6 LED RGB/RGBW Scenes.....	70
5.3.7 LED RGB/RGBW Sequences.....	74
5.3.7.1 Sequences – General settings.....	75
5.3.7.2 Sequences via relative dimming.....	75
5.3.7.3 Predefined sequences (only with sequence type RGBW/HSV).....	76
5.3.7.3 Manual sequences RGBW/HSV.....	78
5.3.8 Tunable White via RGBW.....	82
5.3.8.1 Basic settings.....	83
5.3.8.2 Dim2Warm.....	86
5.3.8.3 Human Centric Light (HCL).....	89
6 Function selection – Dimming Tunable White.....	92
6.1 Communication objects – Default settings.....	93
6.2 Reference ETS-Parameter.....	95
6.2.1 Global Settings.....	95
6.2.2 Tunable White – Control.....	98

6.2.3 Tunable White	99
6.2.3.1 Switch On-/ Off behaviour	99
6.2.3.2 Staircase light	100
6.2.3.3 Dimming speed.....	101
6.2.3.4 Switch-on color temperature with relative dimming	102
6.2.3.5 Status output	102
6.2.3.6 Behaviour after Reset	103
6.2.4 Tunable White Settings	104
6.2.4.1 Basic Settings	104
6.2.4.2 Dim2Warm.....	107
6.2.5 Block and Force Functions	110
6.2.6 Tunable White Bit-Scenes	114
6.2.7 Tunable White Scenes	117
6.2.8 Tunable White Sequences	121
6.2.8.1 Sequences – General settings	121
6.2.8.2 Sequences via relative dimming	122
6.2.8.3 Sequence settings.....	123
6.2.9 Human Centric Light (HCL)	126
7 Index.....	129
7.1 List of Illustration.....	129
7.2 List of Tables.....	131
8 Attachment	133
8.1 Statutory requirements.....	133
8.2 Disposal routine.....	133
8.3 Assemblage.....	133
8.4 Revision history.....	134

2 Overview

2.1 Overview Devices

The description applies to the following LED controllers (order numbers printed in bold letters):

- **AKD-0424V.02** RGBW Controller, suitable for 12/24V CV LED, 3A per channel, 12A total load, Common Anode, flush mounted
 - direct control of RGBW-/RGB-LEDs/4 LED channels
 - Control of Tunable White LEDs
 - Parallel connection of channels possible as well as individual load distribution
 - extensive application

- **AKD-0324V.02** RGB Controller, suitable for 12/24V CV LED, 3A per channel, 9A total load, Common Anode, flush mounted
 - direct control of RGB-LEDs/3 LED channels
 - Control of Tunable White LEDs
 - Parallel connection of channels possible as well as individual load distribution
 - extensive application

- **AKD-0224V.02** LED Controller, suitable for 12/24V CV LED, 3A per channel, 6A total load, Common Anode, flush mounted
 - direct control of 2 LED channels
 - Control of Tunable White LEDs
 - Parallel connection of channels possible
 - extensive application

- **AKD-0424R.02** RGBW Controller, suitable for 12/24V CV LED, 4A per channel, 16A total load, Common Anode, MDRC device
 - direct control of RGBW-/RGB-LEDs/4 LED channels
 - Control of Tunable White LEDs
 - Parallel connection of channels possible as well as individual load distribution
 - extensive application

- **AKD-0424R2.02** RGBW Controller, suitable for 12/24V CV LED, 2A per channel, 8A total load, Common Anode, MDRC device
 - direct control of RGBW-/RGB-LEDs/4 LED channels
 - Control of Tunable White LEDs
 - Parallel connection of channels possible as well as individual load distribution
 - extensive application

2.2 Usage & Possible applications

The AKD-0x24V.02 and AKD-0424R.02 versions of the LED controller have a relay output which is connected to a separate terminal strip. The relay output switches automatically depending on the activated outputs. If no output is active, the relay is switched off. If at least one output is active, the relay switches on. This relay output should be used to switch off the 230V power supply of the power supply unit for the generation of the 12/24V voltage LED voltage. This avoids unnecessary standby consumption see also "2.5 Exemplary circuit diagram".

Alternatively, the relay output can also be parameterized as a simple switching output.

The AKD-0424R2.02 LED controller does not have a relay output, but it is possible to use a switching channel of an external actuator for this purpose with a "relay request via object".

The LED controller in the 2-fold version is designed for the control of up to two 12/24V LEDs. Various dimming and time functions as well as comprehensive scene and locking functions are available for controlling the LEDs. The complete parameter description can be found in chapter 4 " Usage ".

The LED controller in the 3-fold version is designed for the control of 12/24V RGB LEDs or for the control of 3 single LEDs. The controller has all setting options as in the 2-fold version. In addition, control options are available for RGB LEDs in the HSV/RGB colour space. In addition, extensive setting options for sequences and scenes are available here. The complete parameter description can be found in chapter 5 Usage for controlling RGBW/RGB LEDs.

The LED controller in the 4-fold version is designed for the control of RGBW LEDs and is identical in functionality to the 3-fold version supplemented by a fourth channel for the color white. The 4-fold controllers are available as surface-mounted devices and as MDRC devices for control cabinet mounting.

2.3 Functional description

With the MDT LED Controllers different types of LEDs can be dimmed comfortably. Whether as normal lighting switchable/dimmable, used as staircase lighting, bound in lighting scenes or activated as color control in a sequence, much is possible. Four variants are available in the MDT range. With the AKD-0224V.02 (2-channel, flush mounted) simple LEDs and Dual White LEDs can be dimmed with 12/24V. If an additional channel is needed for LEDs or RGB LEDs should be dimmed, the AKD-0324V.02 (3-channel, flush mounted) is the ideal solution. The LED controllers AKD-0424V.02 (4-channel, flush mounted) and AKD-0424R.02 (MDRC mounted) are 4-channel devices and can be used for four independent white LEDs, Dual White LEDs as well as RGB and RGBW LEDs dimming. The LED controllers in the second generation all have a very comprehensive application.

A variety of output functions

As standard, the basic functions switching, relative dimming, absolute dimming, status, staircase lighting, locking function, scene and automatic function are available for each output in the LED controller. Switch-on/switch-off delays and various dimming speeds can be set. Furthermore, central objects and alarm objects are available for overcurrent and overtemperature.

Extensive dimming functions

For dimming the LED lighting you can choose between 4 different dimming curves, e.g. MDT square (recommended), logarithmic, half logarithmic and linear. The global dimming speeds are used to define the switch-on/switch-off speeds for day/night operation and the dimming speeds for relative and absolute dimming for all channels. If a different dimming speed is required in one channel, the parameter can be set individually. The dimming speed can be changed specifically for this channel. The dimming speed can also be set for each scene. For sequences, a dimming speed can also be set indirectly under Transition time to next step

Colour control RGB/RGBW and HSV colour space

The RGB/RGBW colour control and HSV colour space (recommended) colour control options are available for controlling the RGB/RGBW LEDs. The RGB/RGBW colour control is a principle of additive colour mixing. A separate value is assigned to each of the three objects red, green and blue to generate a colour tone. The customer selects a desired color, for example on the color wheel of a visualisation. Behind each color point of the color wheel, the individual values for the colors red/green/blue are available for the respective color mixing. The result of the color is obtained when all three object values meet.

Optimal is the color control via the HSV color space. For HSV, H (hue) stands for the color value, S (saturation) for the color saturation and V (value) for the brightness.

To control the RGB/RGBW LEDs via the HSV color control a value H, S and V is sent. A colour wheel is not required. The colour settings can already be made via relative or absolute dimming with each KNX button. This makes it very easy to adjust the colours perfectly.

The advantage of the HSV method lies in the fact that the desired hue is already very precisely defined with the H value, the values S and V only influence the color intensity and brightness. Whereas in RGB control the hue is only obtained after mixing all values (red, green, blue), and often the exact hue and the corresponding brightness are difficult to determine.

Tunable White (Dual White LEDs)

With Tunable White it is possible to dim the colour temperature of Dual White LEDs, for example, in a spectrum from 2700 Kelvin to 6000 Kelvin, according to the properties of the LEDs.

Depending on the variant of the LED controller, one to two Dual White LEDs or WW/CW single LEDs can be connected. Two special functions are available under the Tunable White function:

- **Dim2Warm** (cosy evening light)
The color temperature of the light is changed more and more towards the 2700 Kelvin range when the lighting is dimmed down. For example switched on with 100% / 4200 Kelvin, dimmed to 5% / 2700 Kelvin. The result is the effect of incandescent lighting.
- **Dynamic Daylight HCL** (Human Centric Lighting, biologically effective light)
With dynamic daylight control, the colour temperature of the lighting changes throughout the day. The lighting starts in the morning with neutral white, changes the colour temperature to cold white at noon and dims to warm white in the evening. The perception of the colour temperature curve corresponds to that of natural daylight. The HCL control system is based either on the time of day or on sunrise / sunset to set the desired colour temperature and brightness. As a special feature, the brightness can also be dimmed automatically depending on the time of day.

Time dependent dimming

With the LED controllers, the individual channels can be dimmed depending on the time of day. For this purpose, the value time-dependent brightness is selected when parameterising the switch-on behaviour of the channel. Ten times with different brightness values are available, for example from 06.00 a.m. with 50%, over 08.00 a.m. with 100% and from 20.00 p.m. with 80% down to 23.00 p.m. to 15%.

If the lighting is switched on at 07.00 a.m., it starts at 75%. By means of the ten times an individual daily program can be arranged and the lighting has automatically always the correct brightness at the correct time. Application, for example, in the bathroom, in the night between 00.00 a.m. and 05.00 a.m. the light switches ON only with 30% ON if required.

Sequences

Different sequences are available in the application for each color scenario.

These can either be predefined sequences such as Colorful, Warm/Cold Colors, TV Simulator, Sunrise, etc., or you can create your own user-defined sequences. For the user defined sequences the control via HSV as well as via RGB/RGBW exists. Per sequence up to 5 steps can be individually defined. The behavior at the end of a Sequence is adjustable. The endless loop option can also be selected for a sequence. This makes it possible to create a variety of lighting arrangements in various segments such as hotels, Museums / exhibitions, medical practices, etc. possible.

Single use / Parallel use / Selectable load distribution

The outputs of the LED controller can be wired differently.

For the sake of simplicity, please refer to the table for the possibilities:

Article No.	Name	Version	Chanel Single operation	channel parallel operation	Selectable load distribution (opt.)
AKD-0424R.02	RGBW LED Controller 4-fold	MDRC	4 x 4A	2 x 8A	3 x 3A / 1x 7A
AKD-0424R2.02	RGBW LED Controller 4- fold	MDRC	4 x 2A	2 x 4A	3 x 1,5A / 1 x 3,5A
AKD-0424V.02	RGBW LED Controller 4- fold	Flush mounted	4 x 3A	2 x 6A	3 x 2,25A / 1x 5,25A
AKD-0324V.02	RGB LED Controller 3- fold	Flush mounted	3 x 3A	1 x 6A 1 x 3A	2 x 2,25A / 1 x 4,5A
AKD-0224V.02	LED Controller 2- fold	Flush mounted	2 x 3A	-----	-----

Table 1: Load distribution

The selectable load distribution is used when powerful white LEDs are used and can optionally be activated in the application.

Intelligent Relay output (16A C-Load, 140µF)

All LED controllers have a relay output which is connected to a separate terminal strip. The relay output switches automatically depending on the active outputs. If no output is active anymore, the relay is switched off. If at least one output is active, the relay switches on. If the 230V mains voltage of the 12/24V power supply unit is switched with the relay, even standby consumption is avoided.

Time-shifted control of the outputs (from HW R5.0)

The channels are controlled time-shifted to each other to make the load of the power supply as even as possible.

Long Frame Support

The LED controllers support long frame support. When programming via the ETS5, long frames (longer telegrams) are sent. These contain more user data per telegram, which significantly shortens the programming time of the LED controllers with the ETS5. For this you need a programming interface which supports the transmission of long frames. MDT offers, for example, the programming interfaces IP Router SCN-IP100.03, IP Interface SCN-IP000.03 and USB Interface SCN-USBR.02..

Updateable via DCA (from device version R3.0)

The MDT Update Tool can be used to update the devices if necessary.

A detailed description of this is available as a suggested solution at

https://www.mdt.de/EN_Downloads_Solutions.html

2.4 Structure & Handling

MDRC devices:

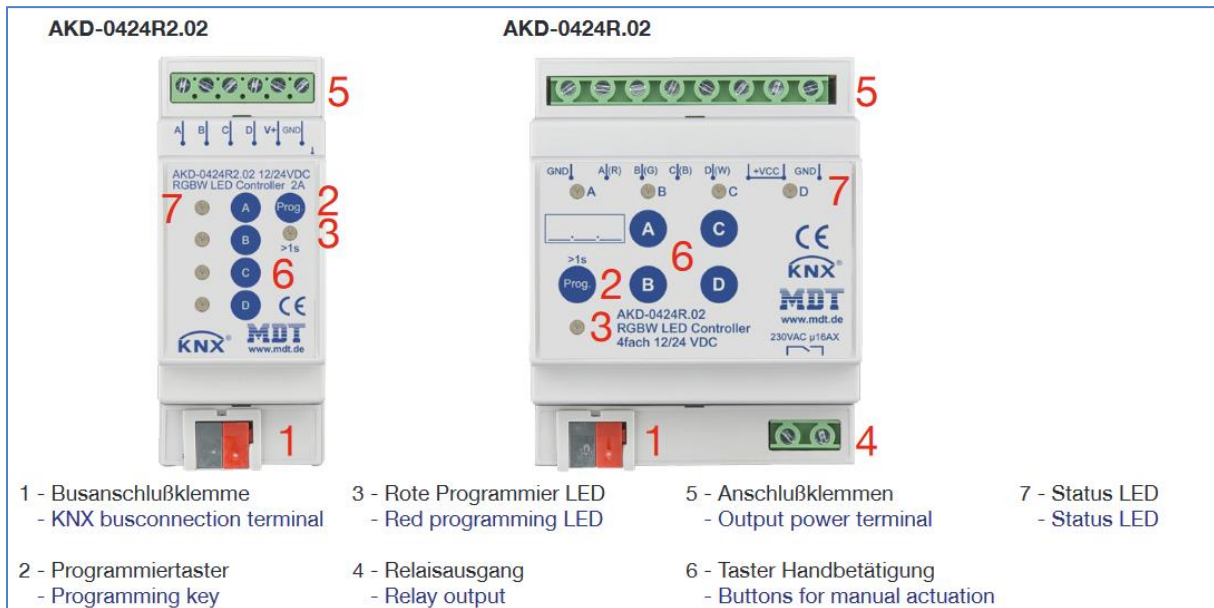

Figure 1: Structure – Hardware module MDRC

Flush mounted devices (Example AKD-0324V.02):

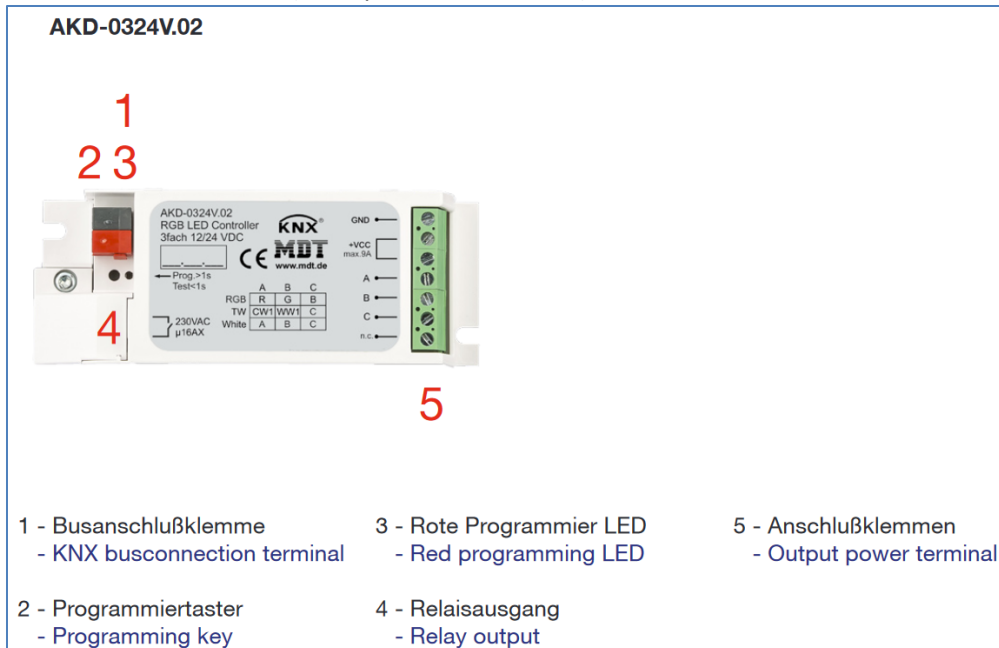

Figure 2: Structure – Hardware module flush mounted device

2.5 Exemplary circuit diagram

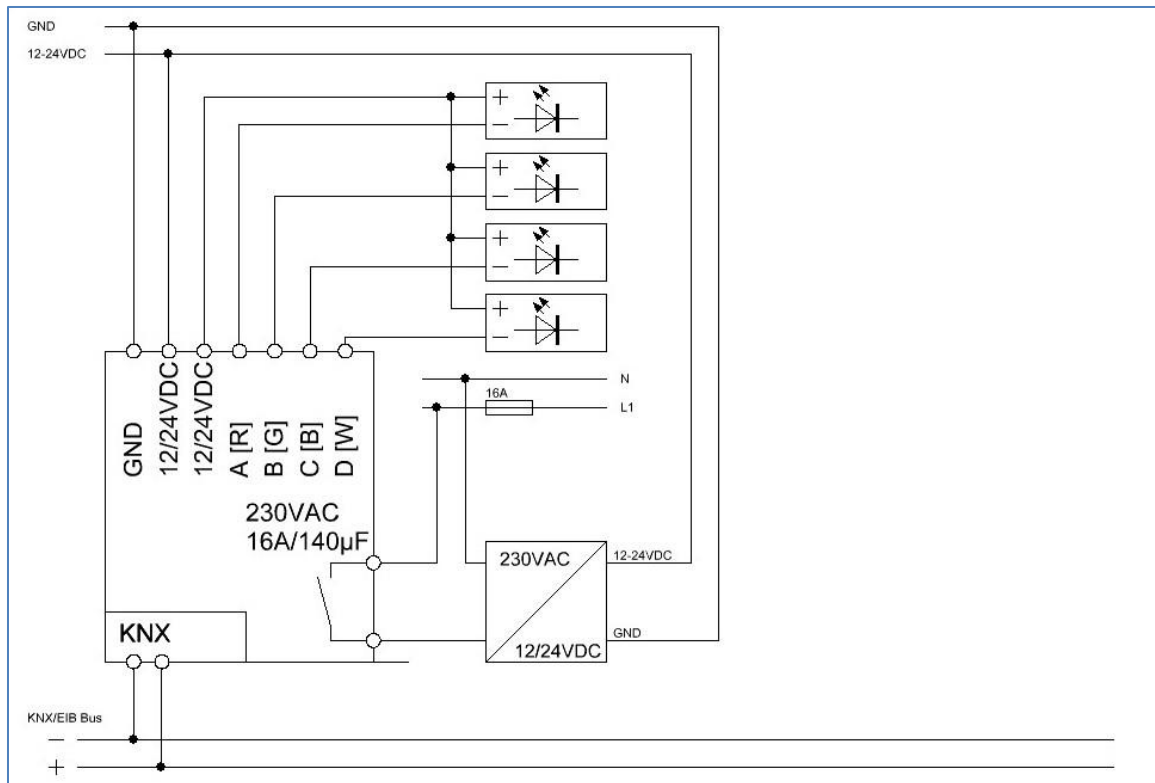

Figure 3: Exemplary circuit diagram, here AKD-0424V.02

2.6 Commissioning

After wiring, the allocation of the physical address and the parameterization of every channel follow:

- (1) Connect the interface with the bus, e.g. MDT USB interface
- (2) set bus power up
- (3) Press the programming button at the device (red programming LED lights)
- (4) Loading of the physical address out of the ETS-Software by using the interface (red LED goes out, as well this process was completed successful)
- (5) Loading of the application, with requested parameterization
- (6) If the device is enabled you can test the requested functions (also possible by using the ETS-Software)

2.7 Testing function

The flush mounted devices (AKD-0224V.02, AKD-0324V.02, AKD-0424V.02) have a built-in test function which can be called via the programming button.

A short keystroke activates the test function, a long keystroke (>1s) activates the programming mode. The test mode activates the channels with the set switch-on value for manual operation (with unprogrammed device 100%). It is switched as follows:

- 1st short press of the programming button: switch on **channel A**
- 2nd short press of the programming button: switch on **channel B**
- 3rd short press of the programming button: switch on **channel C** (only 3/4-fold)
- 4th short press of the programming button: switch on **channel D** (only 4-fold)
- 5th short press of the programming button: switch on **all channels**
- 6th short press of the programming button: switch off **all channels**

The programming mode can be called at any time.

If the programming button is not pressed for 10 minutes, the test mode is automatically switched off and all channels are switched off. The next time the programming button is shortly pressed, the test mode starts again from step 1.

2.8 Behaviour of LEDs – MDRC device

The channel LEDs can indicate the following errors on the MDRC device:

- Single blinking of a channel
Overcurrent of a channel
- Double blinking of all channels
Overtemperature of the entire device
- Triple blinking
Output stage does not respond and one of the outputs is to be switched on.

3 Always valid parameters and communication objects

3.1 Alarms

The LED controller has 2 different alarms. On the one hand an overcurrent alarm, which becomes active as soon as at least one channel leads to a high current, and on the other hand an overtemperature alarm, which becomes active as soon as the output stage becomes too hot. As soon as the overcurrent alarm becomes active, the channel which leads to a high current is switched off. If the overtemperature alarm occurs, all channels are switched off. Thus a damage of the device is avoided. An active alarm is also indicated via the respective communication object. The alarm resets automatically as soon as there is no more fault, but does not switch the channel/power stage on again independently. The outputs are only switched on again with a new switching command after the channel has decayed.

The object **"State of 12/24V power supply"** outputs a 1 as soon as 12/24V is applied to the output.

The following table shows the corresponding communication objects:

Number	Name	Length	Usage
139	Overcurrent alarm	1 Bit	Indicates an active overcurrent alarm
140	Overtemperature alarm	1 Bit	Indicates an active overtemperature alarm
143	State of 12/24V power supply	1 Bit	indicates whether the power stage is supplied with 12/24V

Table 2: Communication objects – Alarms

3.2 Start-up & Operation

The following figure shows the parameters for the device start-up time and the cyclic in-operation telegram:

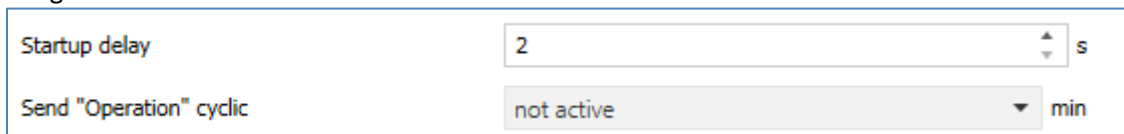

The figure shows a settings interface with two rows. The first row is labeled 'Startup delay' and has a numeric input field containing '2' followed by a unit selector 's'. The second row is labeled 'Send "Operation" cyclic' and has a dropdown menu currently showing 'not active' followed by a unit selector 'min'.

Figure 4: Settings – Startup delay & operation

The device startup time defines the time between a reset and the functional startup of the device. A failure detection can be realized with the "operation" telegram. As long as the device is on the bus, an "On" value is sent cyclically.

The following table shows the corresponding communication objects:

Number	Name	Length	Usage
147	operation	1 Bit	Sends a cyclic status when the device is on the bus.

Table 3: Communication object – Operation

3.3 Day/Night object & Location settings for Time/Date

The following parameters in the menu „Global settings“ are available for the day/night object and time/date:

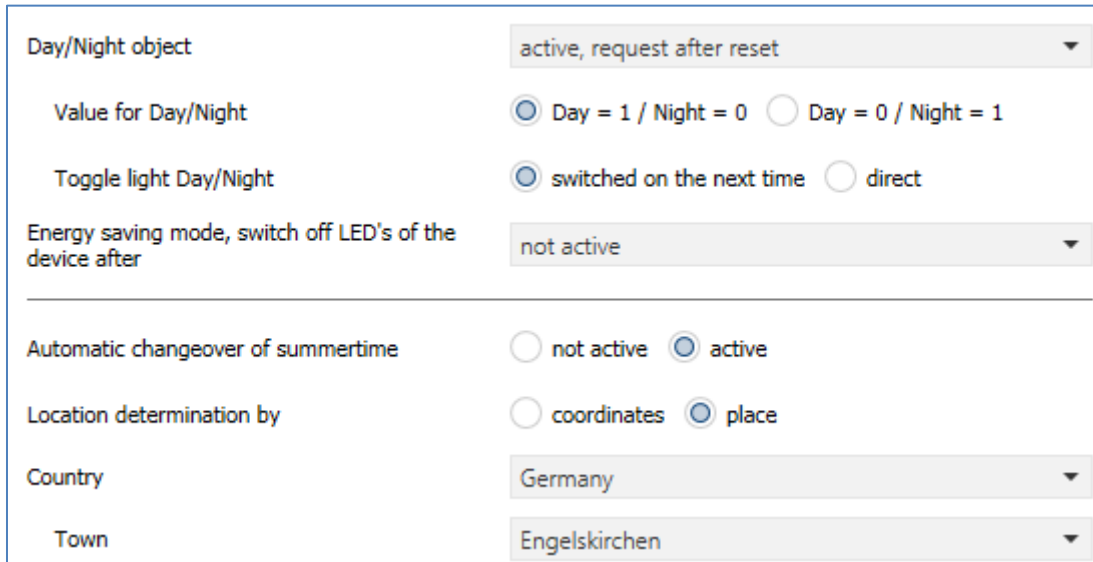

Figure 5: Global Settings – Day/Night object & Time/Date

The **Day/Night object** is used in the various application settings to create a special switch-on behavior for day/night or to set minimum/maximum brightness levels down/up. Via the parameter **Toggle light day/night** it can be determined whether the day/night switch has a direct influence or only at the next switch-on. If the switch-over is only active the next time the unit is switched on, the changes to the corresponding values will only be accepted the next time the unit is switched on. To do this, the channel must be switched to 0% / Off once. If the changeover is to have a direct effect, where the minimum/maximum values for brightness are adjusted directly and if the last switching command was an ON telegram, the channel is also dimmed according to the switch-on behaviour. With the parameter **Energy saving mode, switch off LEDs on device after** (only MDRC device) the LEDs on the device can be deactivated after a certain time. Pressing a key activates the LEDs again for the set time until they are deactivated again.

The **Location determination by** is relevant for the calculation of the sunrise and sunset times, which can be used in time-dependent dimming and HCL.

Basically, the receiving time of a master always continues to run internally. In the case of a time changeover after the Central European time changeover for summer time, the device can carry out the time changeover independently if this is desired via the parameter "**Automatic changeover of summer time**".

The following table shows the associated communication objects:

Number	Name	Length	Usage
144	Time	3 Byte	Receiving the time
145	Date	3 Bytes	Receiving the date
146	Date/Time	8 Bytes	Receiving the date and time
148	Day/Night	1 Bit	Receiving the day/night switchover

Table 4: Communication objects – Day/Night & Time/Date

3.4 Device Selection – MDRC devices

With the release of the LED controller **AKD-0424R2.02** (REG, 2SU, 2A per channel) there is a new feature in the database from V2.3.

Therefore, the device to be used is defined in advance in the general settings:

Device selection

AKD-0424R.02 (4x4A, with relay contact)
 AKD-0424R2.02 (4x2A, without relay contact)

Figure 6: Setting – Device selection MDRC

Since one device is equipped with a relay contact and the other without a relay contact, there are different setting options.

Settings see "4.2.1 Global Settings".

Both devices use the same database. The default setting for the device selection is AKD-0424R.02. When inserting an AKD-0424R2.02, the first thing to do is to select the device manually!

3.5 Description of objects (from DB V2.2)

As of database version V2.2, the parameter "Description of objects" appears at the beginning of each function (single channels, RGB/RGBW or Tunable White).

This makes the assignment of the objects more manageable.

The object designation is a free text field for entering up to 30 characters. If a name is assigned, it appears (here in the example for the function selection RGBW) in the corresponding submenu for the settings and in the name of the communication objects.

Global setting	Description of objects	Kitchen
LED RGBW Settings Kitchen	Staircase light	<input checked="" type="radio"/> not active <input type="radio"/> active

Number	Name	Object Function
64	LED RGBW / HSV / TW Kitchen	Switch
66	LED RGB Kitchen	Color setting
67	LED HSV Kitchen	Color setting

4 Function selection – Single Channels

If the LED controller is to be operated with 2-4 single channels, e.g. with white LEDs, the following selection has to be made in the "Global settings" menu:

Function selection	dimming single channel white
Setting channels	individual
Channel A	<input type="radio"/> not active <input checked="" type="radio"/> active
Channel B	<input type="radio"/> not active <input checked="" type="radio"/> active
Channel C	<input type="radio"/> not active <input checked="" type="radio"/> active
Channel D	<input type="radio"/> not active <input checked="" type="radio"/> active

Figure 7: Settings – Function selection / Single channels

The parameter "Channel setting" can be used to select whether channel pairs (A+B and C+D) are to be connected in parallel. The permissible total current is doubled by connecting two channels in parallel.

If the channels are connected in parallel, only channels A and C can be parameterised. The control for channel B is then equal to channel A and the control for channel D is equal to channel C. However, it is also possible to connect channel A+B in parallel and operate channel C/D individually.

The following settings are possible:

- individual (each channel is controlled individually)
- Channels A+B and Channels C+D parallel
- Channels A+B parallel and single Channels C, D

However, it is absolutely necessary to bridge the channels at the terminals with as short connecting cables as possible.

Please refer to the data sheet for parallel connection!

4.1 Communication Objects – Default Settings

Default Settings – Single channels									
No.	Name	Function	Lenght	C	R	W	T	U	
0	Channel A	Switch	1 Bit	X		X			
1	Channel A	Staircase light	1 Bit	X		X			
2	Channel A	Dim relatively	4 Bit	X		X			
3	Channel A	Dim absolutely	1 Byte	X		X			
4	Channel A	State On/Off	1 Bit	X	X		X		
5	Channel A	State of dimming value	1 Byte	X	X		X		
6	Channel A	Block I	1 Bit	X		X			
7	Channel A	Block II	1 Bit	X		X			
8	Channel A	Block state	1 Bit	X	X		X		
9	Channel A	Scene	1 Byte	X		X			
12	Channel A	Bit Scene 1	1 Bit	X		X			
13	Channel A	Bit Scene 2	1 Bit	X		X			
14	Channel A	Bit Scene 3	1 Bit	X		X			
15	Channel A	Bit Scene 4	1 Bit	X		X			
+16	next Channel								
119	A: Time dependent dimming	Start sequence	1 Bit	X		X			
120	A: Time dependent dimming	Sequence status	1 Bit	X	X		X		
+4	Sequence for next Channel								
135	Central	Central	1 Bit	X		X			
136	Central	Central	4 Bit	X		X			
137	Central	Central	1 Byte	X		X			
138	Central	Central	1 Byte	X		X			

Table 5: Communication objects – Default settings single channels

The default settings can be found in the table above. The priority of the individual communication objects and the flags can be adjusted by the user as required. The flags assign the respective programming tasks to the communication objects, where C stands for Communication, R for Read, W for Write, T for Transfer and U for Update.

4.2 Reference ETS-Parameter

4.2.1 Global Settings

The following parameters are also available in the "Global settings" menu:

Global dimming speed	
Switching on speed at day	2 s
Switching off speed at day	2 s
Switching on speed at night	2 s
Switching off speed at night	2 s
Dimming speed for relative dimming	15 s
Dimming speed of absolute dimming	10 s
<hr/>	
Relais request via object (from R5.0)	not active
Use relais as	<input type="radio"/> switch channel <input checked="" type="radio"/> switching off if all channels = 0%
Off delay of relais	5 s
Switching off delay time of relais in sequence	5 s
Behavior at bus power down	no change
<hr/>	
Brightness of activation during manual operation	100%
PWM frequency	<input checked="" type="radio"/> 600 Hz <input type="radio"/> 1 kHz
Dimming curve	quadratic
Current distribution of channels	<input checked="" type="radio"/> 100% nominal current for all channels <input type="radio"/> channels A,B,C 75%; channel D 175%
Reduction of brightness Channel A	0% (full output power)
Reduction of brightness Channel B	0% (full output power)
Reduction of brightness Channel C	0% (full output power)
Reduction of brightness Channel D	0% (full output power)
Hold HCL/Sequence active	<input checked="" type="radio"/> not active <input type="radio"/> active
Note: HCL, Sequences, Time dependent dimming can be stopped by other actions.	

Figure 8: Global Settings – Further parameters

The table shows the setting options for the general settings:

ETS-Text	Dynamic range [Default value]	Comment
Global Dimming Speed		
Switch on speed for day	0 ... 120 [2s]	Setting the Soft-Start/Soft-Off times for day/night
Switch off speed for day	0 ... 120 [2s]	
Switch on speed for night	0 ... 120 [2s]	
Switch off speed for night	0 ... 120 [2s]	
Speed for relative dimming	1 ... 120 [15s]	Setting the speed for dimming via relative command
Speed for absolute dimming	0 ... 120 [10s]	Setting the speed for dimming via absolute command
Relais request		
Relais request via object (from R5.0)	<ul style="list-style-type: none"> • Not active • Active (Master) • Active (Slave) 	Setting relay request for master/slave operation. Valid from HW R5.0 and DB V2.3
Relais request type	<ul style="list-style-type: none"> • Simple Request • Monitoring period 	Set the type for the relay request. Parameter is only displayed if Master or Slave is active
Send relais request cyclic	<ul style="list-style-type: none"> • Not active • 1 min – 1 h 	Activation of the cyclic relay request. Parameter is only displayed if slave is active
Use relay as	<ul style="list-style-type: none"> • Switch channel • Switch-off if all channels = 0% 	Setting whether the relay is to be used as a separate switching channel or whether the relay is to switch off in standby mode
Switch off delay of the relay	200 ms – 2 h [5s]	Delay until relay switches off after all channels are at 0%. Parameter is only displayed if "Use relay as" is set to "Switch off if all channels = 0%"
Switch off delay of the relay in sequence	200 ms – 2 h [5s]	Delay until relay switches off after all channels within a sequence are at 0%. Parameter is only displayed if "Use relay as" is set to "Switch off if all channels = 0%"
Switch off delay of relay request	200 ms – 2 h [5s]	Delay time until the object switches off for the relay request. Parameter is only displayed if "active (slave)" is set.

Switch off delay of relay request during sequence	200 ms – 2 h [5s]	Delay time until the object for the relay request switches off during a sequence. Parameter is only displayed if "active (slave)" is set
Behaviour at bus power down	<ul style="list-style-type: none"> • No change • Relay switch-off • Relay switch-on 	Setting the behaviour of the relay in the event of a bus voltage failure
Switch on brightness for manual operation	0% – 100% [100%]	Setting the switch-on brightness when the device is controlled manually. Parameters only available for MDRC variant!
PWM Frequency	<ul style="list-style-type: none"> • 600Hz • 1kHz 	Setting the PWM-frequency
Dimming curve	<ul style="list-style-type: none"> • quadratic • logarithmic • semi-logarithmic • linear 	Setting the dimming behaviour. It is recommended to use the square dimming curve
Current distribution of channels	<ul style="list-style-type: none"> • 100% nominal current for all channels • Channels A,B,C 75%, Channel D 175% nominal current • Channels A,B 75%, Channel D 150% nominal current 	Setting the current distribution of the channels - only for 4-channel device - only for 3-channel device
Reduction of brightness Channel A-D	0-50% [0% volle Ausgangsleistung]	Reducing the maximum output power for the channel
Hold HCL/Sequence active	<ul style="list-style-type: none"> • not active • active 	This parameter determines whether HCL, time-dependent dimming and sequences can be stopped by other actions.

Table 6: Global settings

Current distribution of channels:

With the parameter current distribution a higher maximum current can be made available to a channel. This is useful, for example, if you have a lamp band that requires more current than the other colors.

Reduction of brightness Channel A-D:

The limitation of the output power is used to scale the brightness for a channel down by the specified percentage, e.g. if a light band is clearly too bright. All status values, dimming values still refer to 100% after scaling, but the brightness is reduced by the specified percentage.

Hold HCL/Sequence active:

With this parameter, a sequence is not stopped by On/Off, relative dimming, absolute dimming, etc. The action is performed and the end value is held until the current waiting time/dimming time has elapsed. It is only possible to stop the actual sequence with the following actions:

- Stopping the sequence/HCL via the respective sequence object
- Starting another sequence/HCL
- Switch-on action via switching On/Off
- Switch-off action via switching On/Off
- blocking action
- unblocking

The relay can be used both to switch off the power supply when all channels are off - to avoid standby consumption - and as a separate switching channel. If a power supply is switched on with a delay, the action will be delayed until the 12V/24V are available. This ensures a clean dimming behaviour.

If the relay is used as a separate switching channel, a new communication object appears for control. The following table shows the corresponding communication object:

Number	Name	Length	Usage
141	Relay – Switch On/Off	1 Bit	Switching the relay if it has been selected as the switching channel
142	Relais - State	1 Bit	Status output whether relay is switched

Table 7: Communication objects – Relay as switching channel

The relay request (from R5.0) can be configured as master or slave. The objects then change for the relay. The LED controller without relay contact can only be configured as slave. Due to the possibility Master / Slave several controllers can work with one voltage source which the Master switches with its relay.

Number	Name	Length	Usage
141	Relay request	1 Bit	Input for relay request
142	Relay state	1 Bit	State output

Table 8: Communication objects – Relay request Master

Number	Name	Length	Usage
142	Relay request output	1 Bit	Output for relay request

Table 9: Communication objects – Relay request Slave

4.2.1.1 Channel activation

Each channel can be individually activated or deactivated. This can be done with the following setting:

Channel A	<input type="radio"/> not active	<input checked="" type="radio"/> active
Channel B	<input type="radio"/> not active	<input checked="" type="radio"/> active
Channel C	<input type="radio"/> not active	<input checked="" type="radio"/> active
Channel D	<input type="radio"/> not active	<input checked="" type="radio"/> active

Figure 9: Settings – Channel activation

The table shows the setting options for channel activation:

ETS-Text	Dynamic range [Default value]	Comment
Channel A-[D]	<ul style="list-style-type: none"> • not active • active 	Activation of the respective channel

Table 10: Settings – Channel activation

If a channel is activated, this channel appears in the left selection menu as setting Channel [A-D]. By selecting the tab for this channel, further parameterization can be carried out for this channel. In addition, when the channel is activated, a tab for additional settings of the respective channel is displayed and the corresponding communication objects are displayed.

A channel which has been selected as "not active" cannot be parameterised any further. No communication objects are displayed for deactivated channels

4.2.2 Operation / Basic functions

The basic functions of the normal dimming / switching function are divided into three areas: switching, relative dimming and absolute dimming. As soon as a channel is activated, the communication objects for the basic functions are displayed as standard.

4.2.2.1 Switching

The channel can be switched on or off with the switching command. There is also a signalling object which indicates the current switching state of the output. This object can be used for visualisation purposes. If the LED actuator is to be switched via a binary input using the switch-over function, the object has to be connected to the status object of the binary input, "Value for toggle"..

Number	Name	Length	Usage
0	Switch	1 Bit	Switches the channel on or off
4	State On/Off	1 Bit	Indicates the current state of the channel

Table 11: Communication objects – Switch

4.2.2.2 Dimming relative

Relative dimming permits a stepless dimming. This allows the connected lamp to be dimmed evenly from 0 to 100% upwards or from 100 to 0% downwards. Relative dimming can be stopped at any state. The behaviour of the dimming process can be individually adapted via additional parameters, such as the dimming speed.

Number	Name	Length	Usage
2	Dim relative	4 Bit	dims the channel steadily up and down

Table 12: Communication object – Dimming relative

4.2.2.3 Dimming absolute

A fixed brightness level can be set by absolute dimming. A specific brightness value is assigned to the output by sending a percentage value to the 1 byte command " Dim absolute ".

Number	Name	Length	Usage
3	Dim absolute	1 Byte	sets a fixed brightness value

Table 13: Communication object – Dimming absolute

4.2.3 Switch On/Off delay

The switch-on and switch-off delay (switch-off delay not available with activated staircase lighting function) enables delayed switch-on or switch-off.

The following figure shows the two parameters:

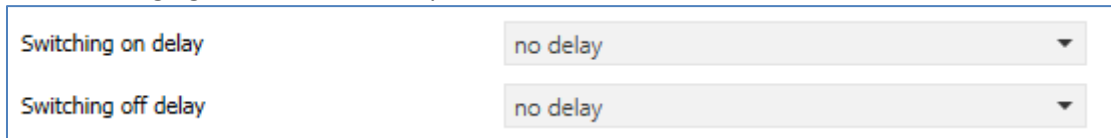

Figure 10: Settings – Switch On/Off delay

The following table shows the setting options for the two parameters, which are identical for both parameters:

ETS-Text	Dynamic range [Default value]	Comment
Switch On delay / Switch Off delay	No delay, 1s, 5s, 10s, 15s, 20s, 30s, 45s, 60s 2/3/4/5/6//7/8/9/10/15/20/30/ 45/60/90/120/180/240 min	Setting the time by which the switch-on process or the switch-off process is to be delayed.

Table 14: Settings – Switch On/Off delay

The switching telegrams of the LED Controller can be delayed with the switch-on delay and the switch-off delay. The delay can occur both during the switch-on process (switch-on delay) and during the switch-off process (switch-off delay). Both functions can also be combined with each other. The following diagram shows the functionality of the two functions, both of which have been activated in this example:

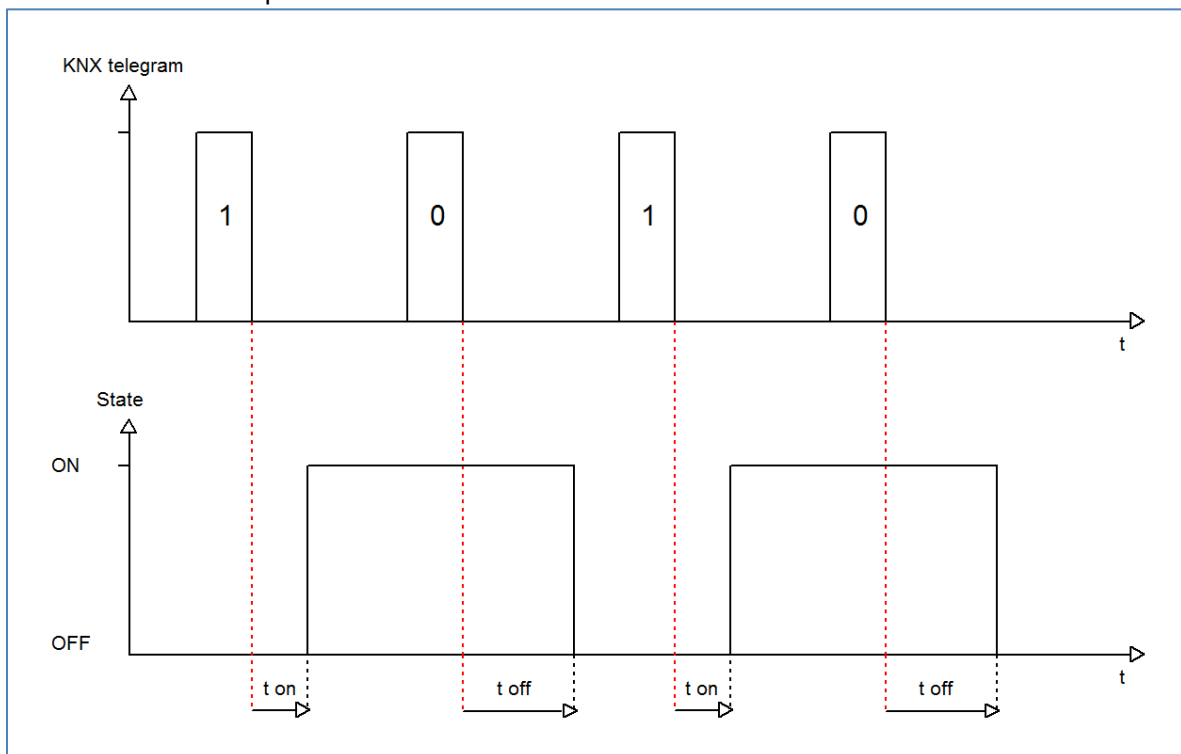

Figure 11: Functional diagram – Switch On/Off delay

4.2.4 Staircase Light

The staircase lighting function enables the channel to be switched off after a certain time value. To be able to parameterise the staircase lighting function further, it first has to be activated. Activation takes place in the parameter for the respective channel:



Figure 12: Setting – Activation Staircase light

If "Staircase Light" is activated, a new submenu "Staircase Light Function" appears in the left-hand selection menu for the corresponding channel [A-D]. Further parameterisation for the staircase light function is carried out there.

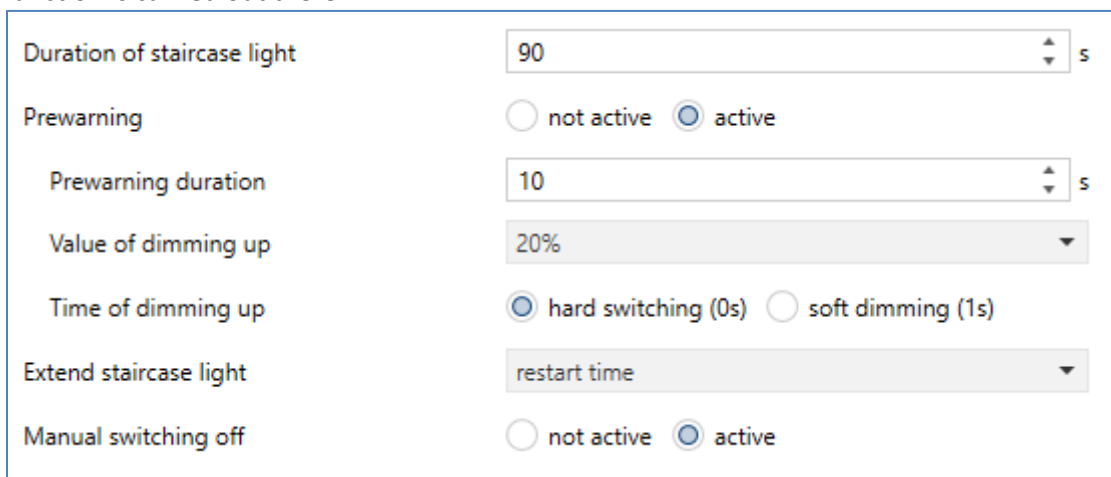

Figure 13: Settings – Staircase light function

The following table shows the setting options for the staircase lighting function:

ETS-Text	Dynamic range [Default value]	Comment
Duration of staircase light	0 ... 14400 s [90 s]	Duration of the switch-on process
Prewarning	<ul style="list-style-type: none"> active not active 	activates the prewarning function
Prewarning duration	0 ... 14400 s [10s]	Sets the duration of prewarning time. Only displayed if prewarning is activated
Value of dimming down	0,5 – 100% [20%]	Value by which the channel is dimmed after the staircase timer has elapsed. Only be displayed if prewarning is activated
Time for dimming up	<ul style="list-style-type: none"> Hard Switching (0s) Soft Dimming (1s) 	Setting the dimming time. Only displayed when prewarning is activated
Extend staircase light	<ul style="list-style-type: none"> Not active Restart time Add up time 	Activation of a possible extension of the staircase light
Manual switching off	<ul style="list-style-type: none"> active not active 	Activation of switch-off before the staircase lighting period has elapsed

Table 15: Settings - Staircase light function

The staircase lighting duration specifies how long the channel is to remain switched on after an ON telegram. After the staircase lighting time has elapsed, the channel switches itself off automatically. For the staircase lighting process, the parameters Extend/Switch off can also be used to set whether the staircase timer can be extended or switched off before the staircase timer has elapsed. If an ON telegram is sent before the staircase timer expires when the extension is active, the staircase lighting function restarts at the set staircase lighting duration. Sending an off telegram, with active switch-off, leads to an immediate switch-off of the channel.

The prewarning function can be used to dim down the lighting after the staircase timer has ended. This serves to warn that the lighting goes out after the prewarning period has elapsed. The lighting is thus dimmed to the set dimming value after the staircase lighting time has elapsed and remains switched on for the set warning time once this value has been reached.

If the staircase light function is activated, the communication object "Switch" disappears and the communication object "Staircase light" appears instead..

Number	Name	Length	Usage
1	Staircase light	1 Bit	activates the staircase light function

Table 16: Communication object – Staircase light

The staircase light function has no influence on relative or absolute dimming.

In the following, the staircase lighting process is illustrated with an activated deactivation and extension. The prewarning is activated with a dim down value of 20%:

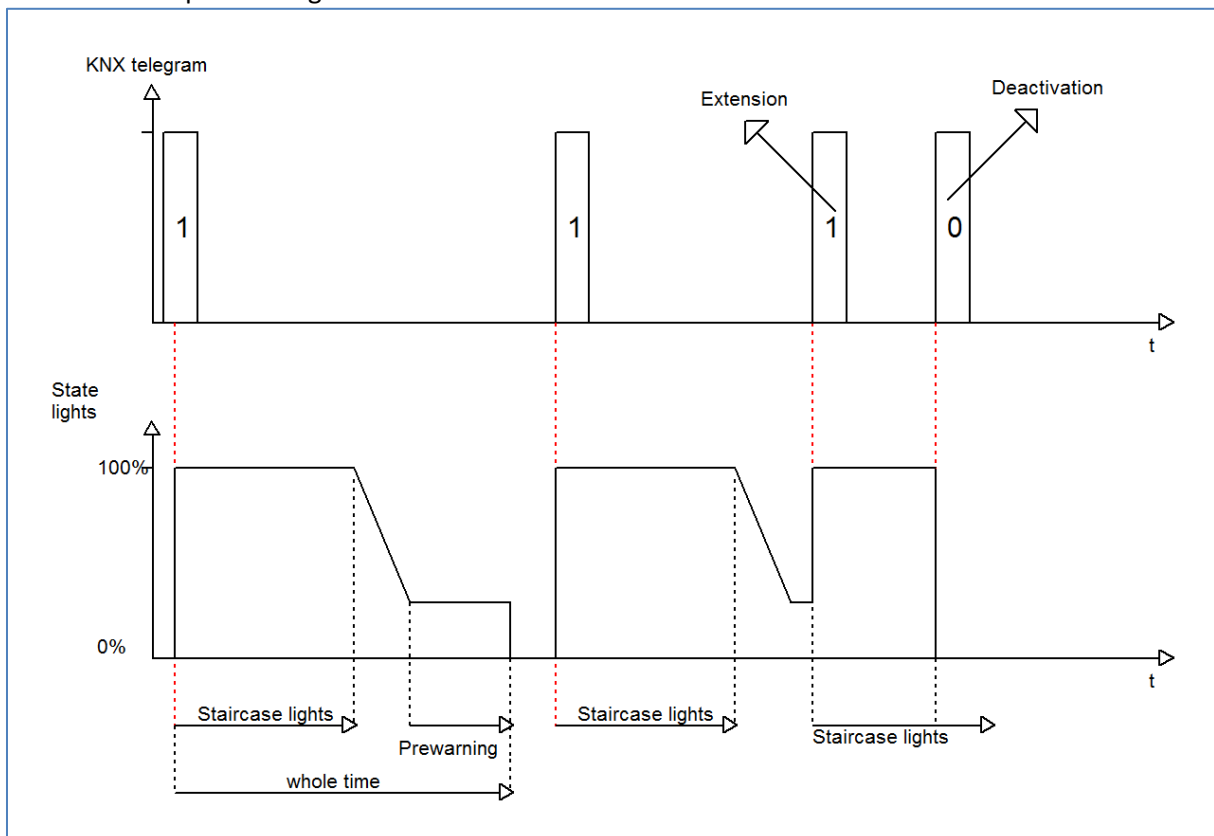

Figure 14: Illustration – Staircase lighting process

4.2.5 Switch On behaviour

The switch-on behaviour function can be used to define the switch-on of the channel:

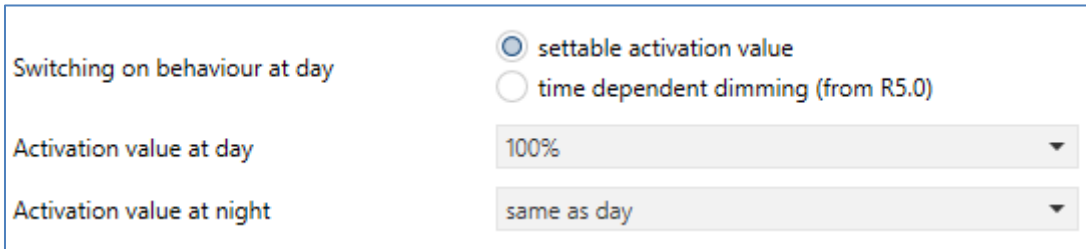

Figure 15: Settings – Switch-on behaviour

The following table shows the possible settings:

ETS-Text	Dynamic range [Default value]	Comment
Switch on behaviour for Day	<ul style="list-style-type: none"> ▪ Adjustable brightness value ▪ Last brightness value (Memory) ▪ Time dependent dimming ▪ Time dependent dimming (from R5.0) 	Setting the switch-on behaviour for day. "Last brightness value (Memory)" is only shown when staircase lighting is "not active" . "Time-dependent dimming" is only possible from R5.0 with the "Staircase lighting active" setting . If "Staircase lighting not active" is set, it is always possible.
Switch on value for Day	0,5 – 100% [100%]	Setting of the switch-on value for the day which is to be dimmed at switch-on. Only displayed with the setting "Adjustable brightness value"
Switch on value for Night	<ul style="list-style-type: none"> ▪ Same as Day ▪ 0,5 – 100% 	Setting of the switch-on value for night which is to be dimmed at switch-on
Apply brightness value to memory when "Off"	<ul style="list-style-type: none"> ▪ not active ▪ active 	Setting whether the last value is to be stored again when the device is switched off or not. Only visible with the setting "last brightness value (memory)"
Switching On delay	<ul style="list-style-type: none"> • No delay • 1 s – 240 min 	Setting whether the channel is switched on with a delay. Only displayed if staircase lighting is "not active"
Switching Off delay	<ul style="list-style-type: none"> • No delay • 1 s – 240 min 	Setting whether the channel is switched off with a delay. Only displayed if staircase lighting is "not active"

Table 17: Settings – Switch-on behaviour

A fixed switch-on value can be assigned to the channel via the "Adjustable brightness value" parameter. The switch-on value covers the entire technically possible range, i.e. from 1-100%. However, if the dimming range is limited, the dimming actuator switches on at least with the minimum brightness value and at most with the maximum brightness value; independent of the set switch-on value.

The "Last brightness value" or "Memory function" parameter causes the dimming actuator to save the value last reached before switching off and to recall this value when switching back on.

If the memory function for day is activated and night is not set to "same as day", the last value will only be saved if day is active.

The parameter "Apply brightness value to memory when off" can be used to set whether the dimming actuator stores the last value each time it is switched off and restores it when it is switched back on. If the parameter is set to „not active“, a new switch-on value is taught-in by triggering a scene / bit scene, insofar as the action "Brightness value if "Off" new switch-on value (memory)" is set in the scene / bit scene.

In addition, the channel can start time-dependent brightness control when it is switched on.

The switch-on behaviour can be parameterised separately for day and night.

4.2.6 Dimming Speed

The dimming speeds can be taken from the global settings or set individually for each channel:

Dimming speed	<input checked="" type="radio"/> individual <input type="radio"/> global settings
Switching on speed at day	2 s
Switching off speed at day	2 s
Switching on speed at night	2 s
Switching off speed at night	2 s
Dimming speed for relative dimming	15 s
Dimming speed for absolute dimming	10 s

Figure 16: Settings – Dimming Speed

The following table shows the available setting options:

ETS-Text	Dynamic range [Default value]	Comment
Dimming speed	<ul style="list-style-type: none"> ▪ individual ▪ global settings 	Setting whether the channel should accept the global dimming speeds or whether individual times should be set for this channel
Switch on speed for day	0 ... 120 [2s]	Setting the soft-start function when switching on via On/Off in day mode
Switch off speed for day	0 ... 120 [2s]	Setting the Soft-Off function when switching on via On/Off in day mode
Switch on speed for night	0 ... 120 [2s]	Setting the soft-start function when switching on via On/Off in night mode
Switch off speed for night	0 ... 120 [2s]	Setting the Soft-Off function when switching on via On/Off in night mode
Dimming speed for relative dimming	1 ... 120 [15s]	Setting the speed for relative dimming commands
Dimming speed for absolute dimming	0 ... 120 [10s]	Setting the speed for absolute dimming commands

Table 18: Settings – Dimming speed

4.2.7 Dimming Range

The "Minimum brightness" and "Maximum brightness" parameters can be used to define a maximum permissible dimming range.

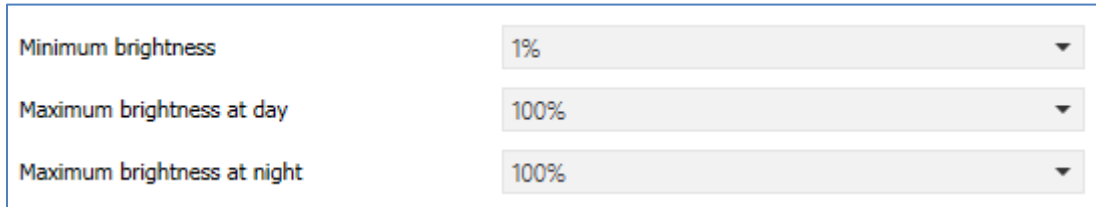

Figure 17: Settings – Dimming Range

The following table shows the setting options for the minimum and maximum brightness value:

ETS-Text	Dynamic range [Default value]	Comment
Minimum brightness	0,5 – 100 % [0,5 %]	lower, minimum permissible brightness value
Maximum brightness for day	0,5 – 100 % [100 %]	Upper, maximum permissible brightness value - Day mode
Maximum brightness for night	0,5 – 100 % [100 %]	Upper, maximum permissible brightness value - Night mode

Table 19: Settings – Dimming Range

If the technically possible dimming range (1-100%) is to be limited to a smaller value, this is possible

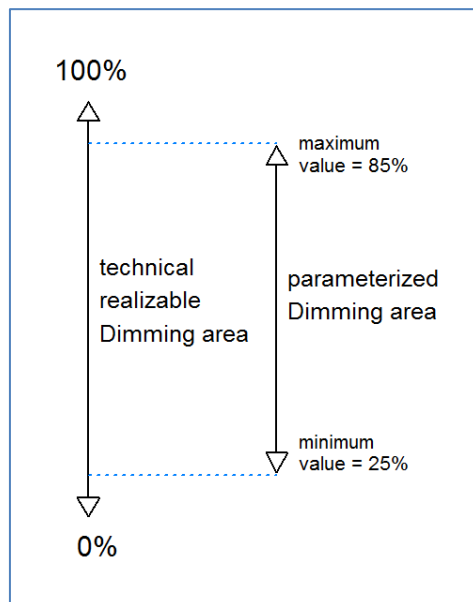

by setting a minimum and maximum brightness value for each channel individually. If the dimming range is limited, the channel only moves within the set limits. This also has consequences for other parameters: if, for example, a maximum brightness value of 85% is set and a switch-on value of 100% is set, the channel will also switch itself on with the highest permissible value of 85%. Exceeding this value is no longer possible. The setting of a dimming range is particularly useful if certain values are not to be reached for technical reasons.

Example: Minimum light = 25%, maximum light = 85%, Value for startup= 100%

- On telegram --> adjusted light value 85%
- 50% telegram --> adjusted light value 50%
- 95% telegram --> adjusted light value 85%
- 15% telegram --> adjusted light value 25%
- Off telegram --> adjusted light value 0% (Off)

4.2.8 Specific Dimming Settings

4.2.8.1 Status output

The communication object has to be activated in order to make the dimming process visible, e.g. via a visualisation:



Figure 18: Settings – Send Status of dimming value

The following table shows the setting options for :

ETS-Text	Dynamic range [Default value]	Comment
Send status of dimming value	<ul style="list-style-type: none"> • At dimming end • At change of 1/5/10/20% 	Activates status object for the current dimming value
Send status objects cyclic	<ul style="list-style-type: none"> • Not active • 1 min – 1 h 	Setting option of sending the dimming value status cyclically and in what time
Send status of dimming value at blocked action	<ul style="list-style-type: none"> • Not active • Active 	Returns the status even if the action is locked

Table 20: Settings – Send status of dimming value

The communication object for the current dimming value is permanently displayed. It transmits the current dimming value according to the set change. The object of size 1 byte then outputs the current dimming value on a change or at the end of dimming.

Via the parameter "Send status dimming value when action blocked", the status output can also be activated when the channel is blocked, for example to report this back to a visual acuity.

The following table shows the associated communication object:

Number	Name	Length	Usage
5	State of dimming value	1 Byte	Indicates the current dimming value in %

Table 21: Communication object – State of dimming value

4.2.8.2 Dimming range under minimum value

The following figure shows the corresponding parameter:

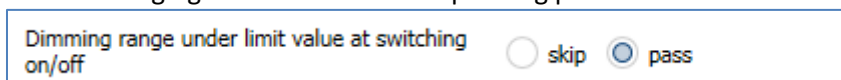

Figure 19: Setting – Dimming range under limit value

With the parameter "Dimming range under limit value when switching on/off" you can set whether the channel should switch on/off abruptly when switching on/off from the minimum value or whether it should dim down the channel to 0% or dimming up from 0%

4.2.8.3 Switch off channel with relative dimming

The following figure shows the parameter "Switch off channel with rel. dimming":

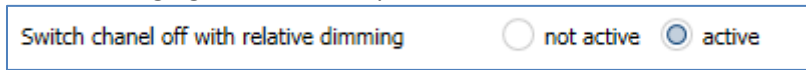

Figure 20: Setting – Switch off with relative dimming

The parameter "Switch off channel with relative dimming" can be used to set whether the channel can be switched off via relative dimming. If this parameter is set to not active, the channel only dims via relative dimming up to the set minimum value and does not switch off the channel.

4.2.9 Central objects

For each channel it can be defined individually whether the channel should react to the central objects. Activation is carried out as follows:

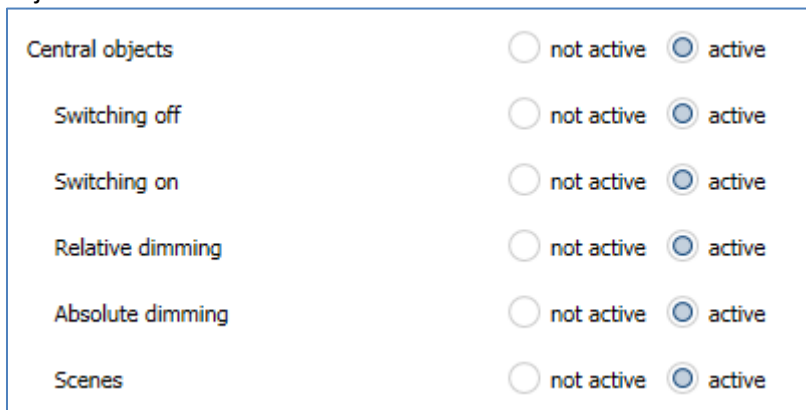

Figure 21: Settings – Central objects

With activation for a channel, the channel reacts to the central objects with its individually settings:

ETS-Text	Dynamic range [Default value]	Comment
Central objects	<ul style="list-style-type: none"> not active active 	activates/deactivates the central objects
Switching off	<ul style="list-style-type: none"> not active active 	Determines whether this channel can be switched off via the central objects
Switching on	<ul style="list-style-type: none"> not active active 	Determines whether this channel can be switched on via the central objects
Relative Dimming	<ul style="list-style-type: none"> not active active 	Determines whether this channel can be dimmed relatively via the central objects
Absolute Dimming	<ul style="list-style-type: none"> not active active 	Determines whether this channel can be dimmed absolute via the central objects
Scenes	<ul style="list-style-type: none"> not active active 	legt fest ob der Szenenaufruf über die zentralen Objekte freigeschaltet ist

Table 22: Settings – Central objects

The following table shows the central communication objects:

Number	Name	Length	Usage
135	Central – Switch	1 Bit	switches all channels with activated central function
136	Central – Dim relative	4 Bit	dims all channels with activated central function
137	Central – Dim absolute	1 Byte	dims all channels via absolute commands with activated central function
138	Central - Scene	1 Byte	Scene recall for all channels with activated central function

Table 23: Communications objects – Central objects

4.2.10 Block and Force Functions

The following figure shows the available setting options in the menu Block and Forced functions:

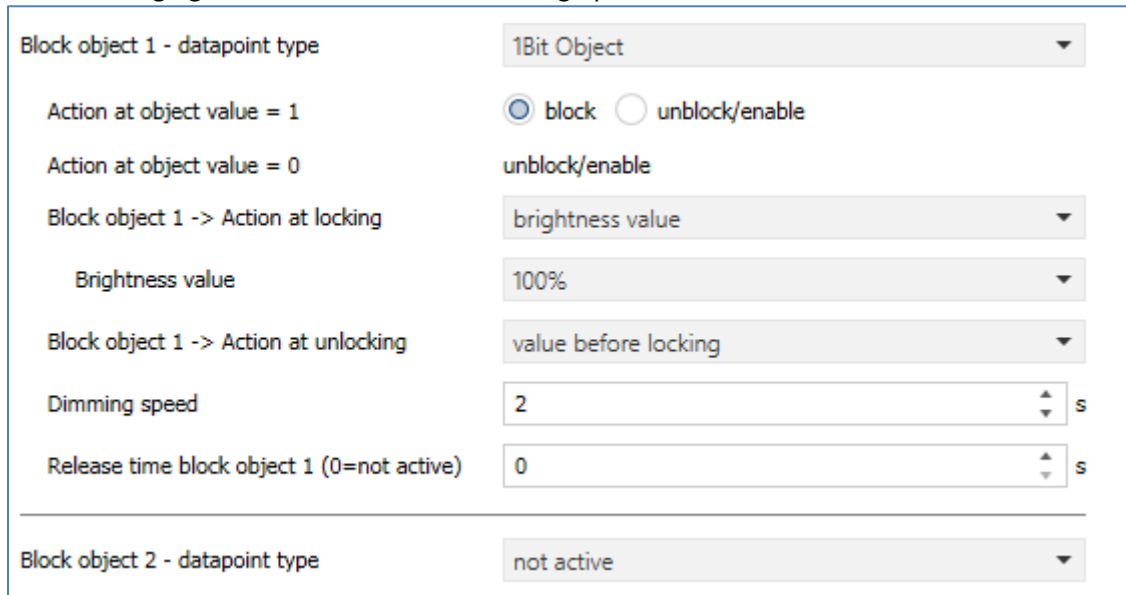

Block object 1 - datapoint type: 1Bit Object

Action at object value = 1: block unblock/enable

Action at object value = 0: unblock/enable

Block object 1 -> Action at locking: brightness value

Brightness value: 100%

Block object 1 -> Action at unlocking: value before locking

Dimming speed: 2 s

Release time block object 1 (0=not active): 0 s

Block object 2 - datapoint type: not active

Figure 22: Settings – Block and Force functions

Each channel has 2 independent blocking functions, whereby blocking function 1 has a higher priority than blocking function 2.

Each block function can be activated/ deactivated by a 1 Bit object, a 2 Bit object or a 1 Byte object.

The following table shows the available setting options for the various blocks:

ETS-Text	Dynamic range [Default value]	Comment
Block object 1/2 – Data point type	<ul style="list-style-type: none"> • not active • 1 Bit Object • 2 Bit Object • 1 Byte dimming value 	Selection of whether the blocking object is active and, if so, with which datapoint type it is to be executed
Selection: via 1 Bit object		
Block object 1/2 – Data point type	<ul style="list-style-type: none"> • 1 Bit Object 	Selection of the data point type for the lock object
Action at object value = 1	<ul style="list-style-type: none"> • block • unblock/enable 	Setting whether value 1 is to be locked or unlocked
Action at object value = 0	is determined automatically after selection of the action with object value = 1	Setting whether to lock or unlock at value 0; is automatically defined by action at value = 1
Selection: via 2 Bit object		
Block object 1/2 – Data point type	<ul style="list-style-type: none"> • 2 Bit Object 	Selection of the data point type for the lock object
Action at object value Force ON	block	With object value Force ON, the channel is always blocked; cannot be set
Action at object value Force OFF	<ul style="list-style-type: none"> • Block -> Off • No change 	Setting of the action to be performed in case of force OFF
Action at object value Force End	unblock/enable	With object value Force end, the channel is always unlocked. Not adjustable
Selection: via 1 Byte object		
Block object 1/2 – Data point type	<ul style="list-style-type: none"> • 1 Byte Object 	Selection of the data point type for the lock object
Aktion bei Dimmwert = 0%	unblock/enable	With object value 0%, the channel is always unlocked. Not adjustable

Block object 1/2 -> Action at locking	<ul style="list-style-type: none"> • Deactivation • Activation value (Day/Night) • Hold value/no change • Brightness value • Time dependent dimming • Disable time dependent dimming 	Setting the action at locking
Brightness value	0 – 100% [100%]	Setting a fixed brightness value. Only available when Lock Action is set to Brightness Value.
Block object 1/2 -> Action at unlocking	<ul style="list-style-type: none"> • Deactivation • Activation value (Day/Night) • Hold value/no change • Brightness value • Update value • Value before locking • Time dependent dimming • Disable time dependent dimming 	Setting the action when unlocking
Dimming speed	0 ... 120 s [2s]	Setting the dimming speed for calling up a brightness value
Release time block object 1/2 (0 = not active)	0 ... 32000 s [0s]	Setting whether the disable function is automatically reset after a defined time.

Table 24: Settings – Block and Force functions

Disable functions 1 and 2 can be triggered with 3 different data point types. The behavior is then as follows:

- **1 Bit Object**
It can be freely defined whether the channel with the "0" or the "1" is to be locked/unlocked. The actions for locking/unlocking can also be set.
- **2 Bit Object**
By means of 2 bit forced control, the channel is blocked with object value Force ON (11). The channel is unlocked with object value Forced end (00). The action for Forced Off (10) can be set to "Block -> Off" or "No change".
- **1 Byte Object (dimming value)**
By means of a 1 byte object, the channel is set to the corresponding value via a dimming value >0% and locked. The value 0% unlocks the channel again.

The following actions can be defined for blocking (no action can be defined for the blocking function via 1 byte object, as the channel is set to the transmitted value here) and unblocking:

- **Deactivation**
The channel will be switched off.
- **Activation value (Day/Night)**
The channel is set to the currently valid switch-on value (depending on whether it is day or night).
- **Hold value / no change**
The channel remains in its current state.
- **Brightness value**
A freely adjustable brightness value (0-100%) is controlled.
- **Update value**
The value of the channel is updated, i.e. the actions that were sent during the lock will be made up.
- **Value before locking**
The channel restores the value it had before the locking..
- **Time dependent dimming**
The channel starts time-dependent dimming.
- **Disable time dependent dimming**
The channel switches off time-dependent dimming.

The following table shows the locking objects:

Number	Name	Length	Usage
6	Block 1	1 Bit 2 Bit 1 Byte	Block object 1 for channel A, type depends on the data point settings for the first block object.
7	Block 2	1 Bit 2 Bit 1 Byte	Block object 1 for channel A, type depends on the data point settings for the second block object.
8	Block state	1 Bit	Sends a 1 if the channel is blocked and a 0 if the channel is not blocked

Table 25: Communication objects – Locking functions

4.2.11 Scenes

When functions of different groups (e.g. light, heating and shutter) shall be changed simultaneously with only one keystroke, it is practical to use the scene function. By calling a scene, you can switch the lights to a specific value, drive the shutter to an absolute position, switch the heating to the day mode and switch the power supply of the sockets on. The telegrams of these functions can have as well different formats as different values with different meaning (e.g. “0” for switch the lights off and open the shutters). If there were no scene function, you would have to send a single telegram for every actuator to get the same function.

The scene function of the switch actuator enables you to connect the channels of the switch actuator to a scene control. For that, you have to assign the value to the appropriated space (scene A..H). It is possible to program up to 8 scenes per switching output. When you activate the scene function at the switching output, a new sub menu for the scenes appears at the left drop down menu. There are settings to activate single scenes, set values and scene numbers and switch the memory function on/off at this sub menu.

Scenes are activated by receiving their scene numbers at the communication object for the scenes. If the memory function of the scenes is activated, the current value of the channel will be saved at the called scene number.

The communication objects of the scenes have always the length of 1 byte

The following figure shows the parameter for the scene function:

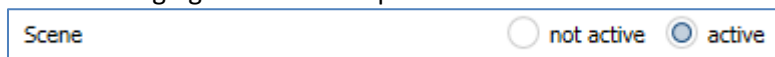

Figure 23: Setting – Activation Scene

The following table shows the respective communication object for an activated scene:

Number	Name	Length	Usage
9	Scene	1 Byte	Call-up of the respective scene

Table 26: Communication object – Scene

For calling a certain scene, you have to send the value for the scene to the communication object. The value of the scene number is always one number less than the adjusted scene number. For calling scene 1, you have to send a “0”. So the scene numbers have the numbers from 1 to 64, but the values for the scenes only from 0 to 63.

If you want to call scenes by a binary input or another KNX device, you have to set the same number at the calling device as at the receiving device. The calling device, e.g. a binary input, sends automatically the right value for calling the scene.

If the scene function is activated as shown above, a new menu item for the scene function appears in the left selection menu. In this menu, the further parameterisation for the scene function of this channel can then be carried out.

For each channel there are 8 storage options for the scenes. The 8 memory spaces have the names A-H. Each of the 8 scenes can be assigned one of the 64 possible scene numbers

The following picture shows the setting options in the submenu Scenes:

Save scene	active
Scene number A	1
Action	brightness value
Brightness value	100%
Dimming speed	5 s
Scene number B	not active
Scene number C	not active
Scene number D	not active
Scene number E	not active
Scene number F	not active
Scene number G	not active
Scene number H	not active

Figure 24: Settings – Scenes

The following table shows the setting options for an activated scene:

ETS-Text	Dynamic range [Default value]	Comment
Save scene	<ul style="list-style-type: none"> • not active • active • keep learned scene (no takeover of parameter) 	Setting whether the current value of the scene can be saved (only for action: Brightness value) and whether the value is reset after reprogramming. Save scene active: Saved value is reset after reprogramming. Keep learned scene: Stored value is retained after reprogramming
Scene number A – H	<ul style="list-style-type: none"> • not active • 1-64 	Setting the scene number for scene call-up
Action	<ul style="list-style-type: none"> ▪ Deactivation ▪ Activation value (Day/Night) ▪ Brightness value ▪ Brightness value, when "Off" -> new switch-on value (memory) ▪ Time dependent dimming ▪ Disable time dependent dimming ▪ enable Block 1 ▪ enable Block 2 ▪ unlocking 	Setting the action for scene call-up
Brightness value	0 – 100 % [100 %]	Setting the brightness value if a fixed brightness value is to be called up
Dimming speed	0 ... 14400 s [5 s]	Setting the dimming speed for calling up scenes

Table 27: Settings – Scenes

The following actions can be performed when the scene is called up:

- **Deactivation**
The Channel will be switched off.
- **Activation value (Day/Night)**
The channel calls up the currently valid switch-on value (for day or night).
- **Brightness value**
Der Kanal ruft den eingestellten Helligkeitswert auf.
- **Brightness value, when "Off" -> new switch-on value (memory)**
The channel calls up the set brightness value and applies it for the next switch-on when the channel is off and the switch-on behaviour for this channel is set to the last brightness value (memory).
- **Time dependent dimming**
The channel activates time-dependent dimming.
- **Disable time dependent dimming**
The channel switches the time-dependent dimming off.

- **Enable Block 1**
Block 1 is activated.
- **enable Block 1**
Block 2 is activated.
- **Unlocking**
The channel is unlocked.

To call up a scene or save a new value for the scene, the corresponding code is sent to the corresponding communication object for the scene:

Scene	Call		Save	
	Hex.	Dec.	Hex.	Hex.
1	0x00	0	0x80	128
2	0x01	1	0x81	129
3	0x02	2	0x82	130
4	0x03	3	0x83	131
5	0x04	4	0x84	132
6	0x05	5	0x85	133
7	0x06	6	0x86	134
8	0x07	7	0x87	135
9	0x08	8	0x88	136
10	0x09	9	0x89	137
11	0x0A	10	0x8A	138
12	0x0B	11	0x8B	139
13	0x0C	12	0x8C	140
14	0x0D	13	0x8D	141
15	0x0E	14	0x8E	142
16	0x0F	15	0x8F	143
17	0x10	16	0x90	144
18	0x11	17	0x91	145
19	0x12	18	0x92	146
20	0x13	19	0x93	147
21	0x14	20	0x94	148
22	0x15	21	0x95	149
23	0x16	22	0x96	150
24	0x17	23	0x97	151
25	0x18	24	0x98	152
26	0x19	25	0x99	153
27	0x1A	26	0x9A	154
28	0x1B	27	0x9B	155
29	0x1C	28	0x9C	156
30	0x1D	29	0x9D	157
31	0x1E	30	0x9E	158
32	0x1F	31	0x9F	159
....
64	0x3f	63	0xBF	191

Table 28: Codes for calling and saving scenes

4.2.12 Bit Scenes

The 1 bit scenes can be used to trigger actions for the value 0 and 1. The following picture shows the setting options for bit scenes:

Figure 25: Settings – Bit scenes

The functionality of the bit scenes is analogous to that of the normal scene function, only that an action can be triggered for both the value 0 and the value 1. The bit scenes can be triggered via simple switching functions.

The following settings are available for the bit scenes:

ETS-Text	Dynamic range [Default value]	Comment
Action at „On“/ „Off“	<ul style="list-style-type: none"> ▪ Deactivation ▪ Activation value (Day/Night) ▪ Hold value / no change ▪ Brightness value ▪ Brightness value, when "Off" -> new switch-on value (memory) ▪ Time dependent dimming ▪ Disable time dependent dimming ▪ enable Block 1 ▪ enable Block 2 ▪ unlocking 	Setting for the reception of the value 0/1 on the bit scene object.
Brightness value	0 – 100 % [100 %]	Setting the brightness value if a fixed brightness value is to be called up
Dimming speed	0 ... 14400 s [5 s]	Setting the dimming speed for calling up Bit Scenes

Table 29: Settings – Bit scenes

The following actions can be performed for the value 0/1:

- **Deactivation**
The Channel will be switched off.
- **Activation value (Day/Night)**
The channel calls up the currently valid switch-on value (for day or night).
- **Hold value / no change**
Current value remains
- **Brightness value**
Der Kanal ruft den eingestellten Helligkeitswert auf.
- **Brightness value, when "Off" -> new switch-on value (memory)**
The channel calls up the set brightness value and applies it for the next switch-on when the channel is off and the switch-on behaviour for this channel is set to the last brightness value (memory).
- **Time dependent dimming**
The channel activates time-dependent dimming.
- **Disable time dependent dimming**
The channel switches the time-dependent dimming off.
- **Enable Block 1**
Block 1 is activated.
- **enable Block 1**
Block 2 is activated.
- **Unlocking**
The channel is unlocked.

The following table shows the corresponding communication object for an activated scene

Number	Name	Length	Usage
12	Bit Scene 1	1 Bit	Activate/deactivate the bit Scene 1
13	Bit Scene 2	1 Bit	Activate/deactivate the bit Scene 2
14	Bit Scene 3	1 Bit	Activate/deactivate the bit Scene 3
15	Bit Scene 4	1 Bit	Activate/deactivate the bit Scene 4

Table 30: Communication objects – Bit Scenes

4.2.13 Time dependent Dimming

Each channel can be dimmed automatically during the course of the day via the time of day or sunrise/sunset.

The following figure shows the time-dependent dimming menu:

Switching times	<input checked="" type="radio"/> time <input type="radio"/> sunrise / sunset
Action at brightness change via dimming	<input type="radio"/> time dependent dimming is stopped <input checked="" type="radio"/> time dependent dimming is dimmed
Note: Relative dimming beyond the values of time dependent dimming or absolute dimming stops time dependent dimming. The release time only affects dimmed time dependent dimming.	
Fallback time of brightness	no fallback ▼
Behavior at control object "On"	<input checked="" type="radio"/> restore brightness change <input type="radio"/> reset brightness change
Fallback of brightness at repeated "On"	<input type="radio"/> not active <input checked="" type="radio"/> active
Behavior at control object "Off"	<input type="radio"/> stop sequence <input checked="" type="radio"/> deactivation
<hr/>	
Time 1	06:00 ▼
Brightness	50% ▼
Time 2	08:00 ▼
Brightness	75% ▼

Figure 26: Settings – Time dependent dimming

The following settings are available for time dependent dimming:

ETS-Text	Dynamic range [Default value]	Comment
Switching times	<ul style="list-style-type: none"> ▪ Time ▪ Sunrise / Sunset 	Setting whether to dim according to fixed times or sunrise/sunset times
Action at brightness change via relative dimming	<ul style="list-style-type: none"> ▪ Time dependent dimming is stopped ▪ Time dependent dimming is dimmed 	Setting whether the brightness of time-dependent dimming can be changed using relative dimming commands or whether relative dimming commands stop time-dependent dimming
Fallback time of time dependent dimming after absolute/relative dimming (from R5.0)	<ul style="list-style-type: none"> ▪ No fallback ▪ 1 min – 12 h ▪ Daily change (at 0:00) 	Setting the release time if absolute or relative dimming has been performed. Only shown when "Time dependent dimming is stopped" is active. Only possible from R5.0
Fallback time of brightness	<ul style="list-style-type: none"> ▪ No fallback ▪ 1 min – 12 h ▪ Daily change (at 0:00) 	Setting the release time if time-dependent dimming has been relatively dimmed. Only available if relative dimming has been enabled for time-dependent dimming
Behaviour at control object "On"	<ul style="list-style-type: none"> ▪ Restore brightness change ▪ Reset brightness change 	Setting whether relative dimming is reset when switched back on; Only available if relative dimming has been enabled for time-dependent dimming
Fallback of brightness at repeated „On“	<ul style="list-style-type: none"> ▪ not active ▪ active 	Setting whether the relative dimming is reset on repeated "send on". Only available if relative dimming has been enabled for time-dependent dimming.
Behaviour at control object "Off"	<ul style="list-style-type: none"> ▪ Stop sequence ▪ Deactivation 	Setting whether the channel with the control object is switched off or only the sequence is stopped.
Time 1-10	fixed time from 0-24 o'clock or time depending on sunrise/sunset	Setting the time for the respective base. Depending on the "Switching times" parameter, fixed times or times depending on sunrise/sunset can be set here
Brightness 1-10	0 – 100%	Adjustment of the brightness to be controlled for the respective base point

Table 31: Settings – Time dependent dimming

Time-dependent dimming enables a dimming process to be carried out over an entire day. The channel adjusts the brightness for this channel depending on the time of day. Time-dependent dimming can either be based on sunrise and sunset times (which the dimming actuator calculates itself) or on fixed times. For this purpose, 10 base points (time + brightness value to be controlled) can be defined. The set brightness is then reached at the set time. The LED controller interpolates between the base points, i.e. if, for example, you have set a brightness value of 50% for 8:00am and a brightness value of 75% for 10:00am, the channel will slowly dim from 50% to 75% within these 2 hours.

Time-dependent dimming can also be dimmed down using relative dimming commands (setting: "Action at brightness change via relative dimming - time-dependent dimming is dimmed"). It can only be dimmed down, but not above the set values. With relative dimming, the brightness values of the base points are then adjusted according to the dimming command: If, for example, dimming is reduced by 50%, all brightness values are reduced by 50% (30%→15%, 50%→25%, etc.).

For relative dimming, there are several ways to reset the brightness change:

- **Fallback time of brightness**
The brightness is automatically reset to the parameter value after a set time.
- **Behaviour at control object „On“**
The brightness is reset to the parameter value when a "On" command is sent to the control object (start sequence).
- **Fallback of brightness at repeated „On“**
The brightness is reset to the parameter value when two "On" commands are sent one after the other to the control object (start sequence).

If the parameter value is to be used for dimming upwards, the "Hold HCL/sequences active" parameter (in menu "Global settings") has to be set to "active". Now the channel can be dimmed upwards at any time and remains there until the next interpolation point is reached. From this point on, the channel synchronizes again with time-dependent dimming until the next interpolation point is reached.

The following table shows the associated communication objects:

Number	Name	Length	Usage
119	Start sequence	1 Bit	Activating/deactivating time-dependent dimming
120	Sequence status	1 Bit	Output of status whether time-dependent dimming is active or not

Table 32: Communication objects – Time dependent dimming

5 Function selection – Dimming RGB/RGBW LEDs

➔ **The following settings are not available in the 2-fold LED controller!**

If the LED controller is to be used for controlling RGB LEDs, the following selection has to be made in the "Global settings" menu:

Function selection: dimming RGB LED

Channel D: not active active

Figure 27: Settings – Function selection / Dimming RGB LED

The fourth channel can still be used as a separate single channel (only with 4-fold LED Controller).

The following setting is only available in the 4-fold RGBW LED Controller!

If the device is to be used for controlling RGBW LED LEDs, the following selection has to be made in the "Global settings" menu:

Function selection: dimming RGBW LED

Figure 28: Settings – Function selection / Dimming RGBW LED

This loads the application for controlling 12/24V LEDs with the corresponding parameters and communication objects. The application for RGB and RGBW LEDs only differs with regard to the control of the white LEDs and is otherwise identical..

5.1 Communication objects – Default settings

Description of the objects for TW (with setting "Tunable White via RGBW settings"), see page 91

Default settings – RGB/RGBW								
No.	Name	Function	Length	C	R	W	T	U
0	LED Red	Switch On/Off	1 Bit	X		X		
2	LED Red/ Green/ Blue/ White	Dim relatively	4 Bit	X		X		
3	LED Red/ Green/ Blue/ White	Dim absolutely	1 Byte	X		X		
4	LED Red/ Green/ Blue/ White	State ON/Off	1 Bit	X	X		X	
5	LED Red/ Green/ Blue/ White	State of dimming value	1 Byte	X	X		X	
+16	Next color channel (green, blue, white)							
64	LED RGB/RGBW/HSV	Switch On/Off	1 Bit	X		X		
65	LED RGB(W)/HSV/TW	Staircase light	1 Bit	X		X		
66	LED RGB/RGBW	Color setting	3 Byte	X		X		
67	LED HSV	Color setting	3 Byte	X		X		
68	LED HSV Hue (H)	Dim absolutely	1 Byte	X		X		
69	LED HSV Saturation (S)	Dim absolutely	1 Byte	X		X		
70	LED HSV Brightness (V)	Dim absolutely	1 Byte	X		X		
71	LED HSV Hue (H)	Dim relatively	4 Bit	X		X		
72	LED HSV Saturation (S)	Dim relatively	4 Bit	X		X		
73	LED HSV Brightness (V)	Dim relatively	4 Bit	X		X		
80	LED RGBW/HSV	State On/Off	1 Bit	X	X		X	
81	LED RGB	3 Byte State of dimming value	3 Byte	X	X		X	
82	LED HSV	3 Byte State of dimming value	3 Byte	X	X		X	
83	LED H (Farbton)	State of dimming value	1 Byte	X	X		X	
84	LED S (Sättigung)	State of dimming value	1 Byte	X	X		X	
85	LED V (Helligkeit)	State of dimming value	1 Byte	X	X		X	
89	LED RGB/RGBW	Scene	1 Byte	X		X		
90	LED RGB/RGBW	Start Bit Scene 1	1 Bit	X		X		
91	LED RGB/RGBW	Start Bit Scene 2	1 Bit	X		X		
92	LED RGB/RGBW	Start Bit Scene 3	1 Bit	X		X		
93	LED RGB/RGBW	Start Bit Scene 4	1 Bit	X		X		
94	LED RGB/RGBW	Block 1	1 Bit	X		X		
95	LED RGB/RGBW	Block 2	1 Bit	X		X		
96	LED RGB/RGBW	Block state	1 Bit	X		X		
97	LED RGBW/HSV/TW	Teach-In for white balance	1 Bit	X		X		
119	LED RGBW/HSV/TW	Start Sequence 1	1 Bit	X		X		
120	LED RGBW/HSV/TW	Sequence 1 state	1 Bit	X	X		X	
+2	next sequence							
131	LED TW Human Centric Light (HCL)	Start HCL	1 Bit	X		X		
132	LED TW Human Centric Light (HCL)	HCL State	1 Bit	X	X		X	

Table 33: Communication objects – Default settings RGB/RGBW

The default settings can be found in the table above. The priority of the individual communication objects and the flags can be adjusted by the user as required. The flags assign the respective programming tasks to the communication objects, where C stands for Communication, R for Read, W for Write, T for Transfer and U for Update.

5.2 Color circle representation/ RGBW control

There are 2 ways to control the RGB/RGBW LEDs. On the one hand the LEDs can easily be controlled by RGB/RGBW values. Each color can be assigned a value separately. Thus the user has the possibility to mix the colors himself.

The other possibility is the control via HSV values, the so-called colour circle representation. The hue can be selected via the H-value. The color circle corresponds to the color space of 0°-360° (see cone). If a color is selected, its brightness V and saturation S can be set (see triangle).

The following picture gives a first impression about the color selection by means of the color circle:

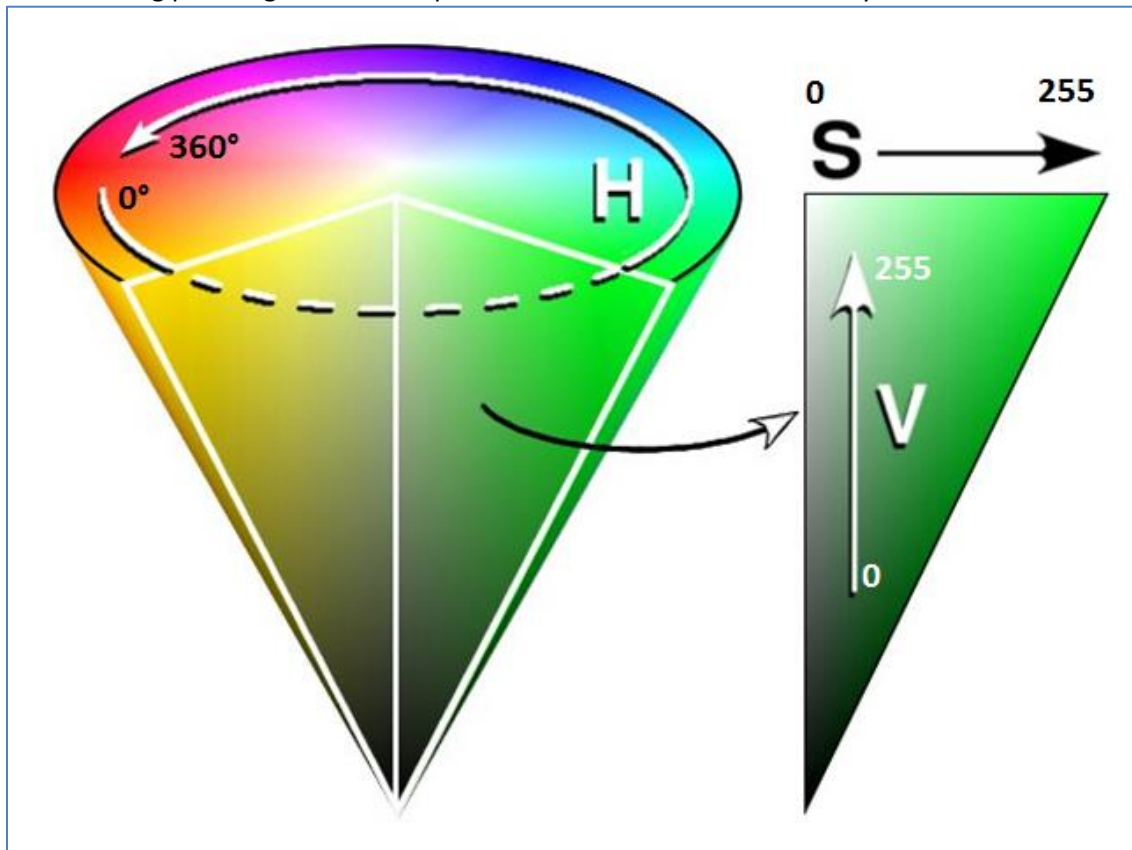

Figure 29: Color Circle representation HSV

It should be noted that each RGB/RGBW LED can react differently depending on the manufacturing tolerances and thus the colors can easily shift. This has to be checked in detail and adjusted if necessary.

5.3 Reference ETS-Parameter

5.3.1 General Settings

The following parameters are available in the "General settings" menu:

Relais request via object (from R5.0)	not active
Use relais as	<input type="radio"/> switch channel <input checked="" type="radio"/> switching off if all channels = 0%
Off delay of relais	5 s
Switching off delay time of relais in sequence	5 s
Behavior at bus power down	no change
<hr/>	
Brightness of activation during manual operation	100%
PWM frequency	<input checked="" type="radio"/> 600 Hz <input type="radio"/> 1 kHz
Dimming curve	quadratic
Current distribution of channels	<input type="radio"/> 100% nominal current for all channels <input checked="" type="radio"/> channels A,B,C 75%; channel D 175%
Reduction of brightness Channel A	0% (full output power)
Reduction of brightness Channel B	0% (full output power)
Reduction of brightness Channel C	0% (full output power)
Reduction of brightness Channel D	0% (full output power)
Hold HCL/Sequence active	<input checked="" type="radio"/> not active <input type="radio"/> active
Note: HCL, Sequences, Time dependent dimming can be stopped by other actions.	

Figure 30: General settings – Dimming RGB/RGBW

The table shows the setting options for the general settings (Settings for relay or relay request see "4.2.1 Global settings, individual channels):

ETS-Text	Dynamic range [Default value]	Comment
Brightness of activation during manual operation	0 – 100% [100%]	Adjustment of the switch-on brightness when the device is controlled via the handset. Parameters only available with REG version!
PWM frequency	<ul style="list-style-type: none"> • 600Hz • 1kHz 	Setting of a PWM-frequency
Dimming curve	<ul style="list-style-type: none"> • quadratic • logarithmic • semi-logarithmic • linear 	Einstellung des Dimmverhaltens. Es wird empfohlen die quadratische Dimmkurve zu verwenden.
Current distribution of channels	<ul style="list-style-type: none"> • 100% nominal current for all channels • Channel A,B,C 75%, Kanal D 175% 	Setting the current distribution of the channels
Reduction of brightness channel A-D	0 – 50% [0% full output power]	Reducing the maximum output power for the channel
Hold HCL/Sequences active	<ul style="list-style-type: none"> • not active • active 	This parameter determines whether HCL, time-dependent dimming and sequences can be stopped by other actions.

Table 34: General settings – Dimming RGB/RGBW

Current distribution of channels:

With the parameter current distribution a higher maximum current can be made available to a channel. This is useful, for example, if the white channel requires significantly more current than the individual colors.

Reduction of brightness channel A-D:

The limitation of the output power serves to scale the brightness for a channel down by the given percentage, e.g. if a light band is clearly too bright. All status values, dimming values still refer to 100% after scaling, but the brightness is reduced by the specified percentage.

Hold HCL/Sequences active:

With this parameter, a sequence is not stopped by On/Off, relative dimming, absolute dimming, etc. The action is performed and the end value is held until the current waiting time/dimming time has elapsed. It is only possible to stop the current sequence with the following actions:

- Stopping the sequence/HCL via the respective sequence object
- Starting of another sequence/HCL
- Switch-on action via switching On/Off
- Switch-off action via switching On/Off
- Locking action
- Unlocking action

The relay can be used both to switch off the power supply when all channels are off - to avoid standby consumption - and as a separate switching channel. If a power supply is switched on with a delay, the action will be delayed until the 12V/24V are available. This ensures a clean dimming behaviour.

If the relay is used as a separate switching channel, a new communication object appears for control. The following table shows the corresponding communication object:

Number	Name	Length	Usage
141	Relais switch On/Off	1 Bit	Switching the relay if it has been selected as the switching channel.
142	Relais state	1 Bit	Status output whether relay is switched

Table 35: Communication objects – Relay as switch channel

The relay request (from R5.0) can be configured as master or slave. The objects then change for the relay. The LED controller without relay contact can only be configured as slave. Due to the possibility Master / Slave several controllers can work with one voltage source which the Master switches with its relay.

Number	Name	Length	Usage
141	Relay request	1 Bit	Input for relay request
142	Relay state	1 Bit	State output

Table 36: Communication objects – Relay request Master

Number	Name	Length	Usage
142	Relay request output	1 Bit	Output for relay request

Table 37: Communication objects – Relay request Slave

5.3.2 Control via HSV or RGBW

As described in the previous section, the LEDs can be controlled both via HSV and RGBW/RGB. The communication objects for both types are displayed by default. They can all be dimmed relatively as well as absolutely.

The following objects are displayed for control via the color wheel representation (HSV):

Number	Name	Length	Usage
68	LED HSV Hue (H) – Absolute value	1 Byte	Vorgabe eines neuen Absolutwertes für den Farbton (in Grad)
69	LED HSV Saturation S – Absolute value	1 Byte	Vorgabe eines neuen Absolutwertes für die Sättigung (in %)
70	LED HSV Brightness V – Absolute value	1 Byte	Vorgabe eines neuen Absolutwertes für die Helligkeit (in %)
71	LED HSV Hue (H) – dimming relative	4 Bit	Veränderung des Farbtons über manuelles, relatives Dimmen
72	LED HSV Saturation S – dimming relative	4 Bit	Veränderung der Sättigung über manuelles, relatives Dimmen
73	LED HSV Brightness V – dimming relative	4 Bit	Veränderung der Helligkeit über manuelles, relatives Dimmen

Table 38: Communication objects – HSV control

For control via RGB/RGBW, the colours are controlled individually. Thus a communication object for manual or absolute control is also available for each color:

These objects are only visible if the "Single channel control" is set to „active (not recommended)“:

Single-channel control not active active (not recommended)

Figure 31: Setting – Activation Single channel control

Number	Name	Length	Usage
2	LED Red – dim relative	4 Bit	Relative dimming of the colour red
3	LED Rot – dim absolute	1 Byte	Setting a new absolute value for the color red (in %)
18	LED Green – dim relative	4 Bit	Relative dimming of the colour green
19	LED Green– dim absolute	1 Byte	Setting a new absolute value for the color green (in %)
34	LED Blue – dim relative	4 Bit	Relative dimming of the colour blue
35	LED Blue – dim absolute	1 Byte	Setting a new absolute value for the color blue (in %)
50	LED White – dim relative	4 Bit	Relative dimming of the colour white
51	LED White– dim absolute	1 Byte	Setting a new absolute value for the color white (in %)

Table 39: Communication objects – RGB/RGBW control

The dimming speeds as described in 5.3.3.3 Dimming speeds are maintained both for relative dimming of the individual values and for the specification of a new absolute value.

In addition, there is a control via a 3-byte object for control via RGB as well as via HSV:

Number	Name	Length	Usage
66	LED RGB color setting	3 Byte	Color setting of RGB values via 3 bytes
67	LED HSV color setting	3 Byte	Color setting of HSV values via 3 bytes

Table 40: Communication objects – 3Byte color settings

If the color is set via 3 bytes, the first byte corresponds to the value for red, the second byte to the value for green and the third byte to the value for blue.

For HSV control, the first byte is the hue value, the second byte is the saturation value and the third byte is the brightness value.

The 3 byte object corresponds to the data point type DPT 232.600.

5.3.3 LED RGB/RGBW Settings

Alle Parameter im Kapitel 5.5.3 beziehen sich auf das Menü LED RGB/RGBW-Einstellungen.

5.3.3.1 White balance/Teach-In

With the white balance it is possible to teach a clear pure white to poorly tuned RGB LEDs. Using the color circle theory as a yardstick, the mixing ratio of the same intensities of the 3 colors red, green and blue should result in the color white. With RGB LEDs, this would mean that if red, green and blue are switched to 100%, the color white should be reproduced. In reality, however, this often looks different. It may well be that this mixing ratio has a distinct blue or red tint. A white balance was introduced to compensate for this color distortion. This causes the colors to be adjusted proportionally so that if the user sets all colors to 100% after carrying out the teach-in, the previously set natural white is called. This white is thus stored as a reference for the pure white. It should be noted with the white balance that the white balance always reduces the maximum brightness, since the dominant colors must be adjusted downwards.

The white balance can be set via a teach-in or fixed via the parameters.

White balance via Teach-In:

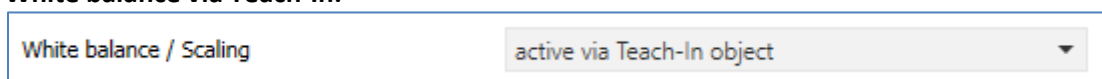

Figure 32: Setting –White balance via Teach-In

The corresponding communication object, which is used to control the teach-in process, is then displayed:

Number	Name	Length	Usage
97	Teach-In for White balance	1 Bit	Starts and stops the white balance

Table 41: Communication object – White balance/Teach-In

The teach-in procedure is as follows:

1. Send the value 0 to the communication object "Teach-In for white balance". Red, green and blue are then set to 100%. For RGBW LEDs, white is also set to 0%.
2. Now the colours red, green and blue have to be reduced with either relative or absolute dimming commands until a pure white is produced. If, for example, the color blue clearly dominates, it must be lowered until an equal balance is achieved.
3. Now the value 1 has to be sent to the communication object "Teach-In for white balance" in order to terminate the teach-in process again. The proportionality of the 3 colours is written to the memory of the device. At the same time, the 3 colours are reset to 0%.
The white balance has now been successfully carried out.

The white balance is retained even in the event of reprogramming or a bus voltage failure.

To reset the white balance: Send a 0 command to the teach-in object and send a 1 command directly afterwards (without sending any dimming commands).

White balance via parameters:

White balance / Scaling	active via parameter ▼
Scaling Red	100% ▼
Scaling Green	100% ▼
Scaling Blue	100% ▼
Scaling White	100% ▼

Note: The scaling is not recognizable by the status dimming value.

Figure 33: Settings – White balance via parameters

With white balance via parameters, the values for the individual colors are assigned to the channel at which a pure white is produced.

5.3.3.2 Status output

Various status objects can be displayed to visualise the dimming process. There are both "individual status objects" and combined 3-byte status objects. The following figure shows the possible settings:

Status output:

Output RGBW State - 4x 1Byte during dimming procedure and at dimming end ▼

Output HSV State - 3x 1Byte at dimming end ▼

Output RGBW/HSV State - combination object not active at dimming end

Send change during the dimming procedure 2% ▼

Note: The status is sent a maximum of once in the second.

DPT for RGB/RGBW Combination object RGB value (3Byte - DPT 232.600) RGBW value (6 Byte - DPT 251.600)

Figure 34: Settings – Status output

The following communication objects are only visible if "Single channel control" is set to "active" in the "LED RGB/RGBW setting" menu:

Single-channel control not active active (not recommended)

Figure 35: Settings – Activation Single-channel control

The parameter "Output RGB/RGBW Status" indicates the status objects for each individual color:

Number	Name	Length	Usage
5	LED Red - State of dimming value	1 Byte	Output of the status 0-100% for the color red
21	LED Green - State of dimming value	1 Byte	Output of the status 0-100% for the color green
37	LED Blue - State of dimming value	1 Byte	Output of the status 0-100% for the color blue
53	LED White - State of dimming value	1 Byte	Output of the status 0-100% for the color white

Table 42: Communication objects – Status output RGB/RGBW

The parameter "Output HSV Status" displays the individual status objects for hue (H), saturation (S) and brightness (V):

Number	Name	Length	Usage
83	LED HSV Hue (H) – state of dimming value	1 Byte	Output of the status 0-360° for the hue in the color wheel
84	LED HSV Saturation (S) – state of dimming value	1 Byte	Output of status 0-100% for saturation
85	LED HSV Brightness (V) – state of dimming value	1 Byte	Output of status 0-100% for brightness

Table 43: Communication objects – Status output HSV

Via the parameter "**Output RGBW/HSV Status**", combined status objects of size 3 bytes can also be displayed. The combined status objects are structured in such a way that the communication object HSV outputs the value H in the first byte, the value S in the second byte and the value V in the third byte. The 3 byte status object RGB has a similar structure (byte 1 = red, byte 2 = green, byte 3 = blue). Even with RGBW LEDs, however, this object is only 3 bytes long, so that the value for white is not displayed in this object.

The parameter "DPT for RGB/RGBW combination object" can be used to set whether the RGB status is converted to an RGBW status and the value for white is also output..

Number	Name	Length	Usage
81	LED RGB	3 Byte	Output of status values for red, green and blue
81	LED RGBW	6 Byte	Output of status values for red, green, blue and white
82	LED HSV	3 Byte	Output of status values for H, S and V

Table 44: Communication objects – Status Combination object

To avoid too much bus load, the status output can be disabled while sequences are being played with the parameter "Output status while sequences".

5.3.3.3 Dimming speeds

Several dimming speeds can be set to set transitions and Soft-Start/Stop:

Dimming speeds:	
Relative dimming Hue (H)	10 s
Relative dimming Saturation (S)	10 s
Relative dimming Brightness (V)	10 s
Absolute dimming	1 s

Figure 36: Settings – Dimming speeds

The individual parameters have the following effects:

- **Relative dimming Hue (H)**
This defines the time for the relative dimming of the color value.
- **Relative dimming Saturation (S)**
This defines the time for relative dimming of the saturation.
- **Relative dimming Brightness (V)**
This defines the time for relative dimming of the brightness.

The times for relative dimming refer to a relative dimming process of 100%. If a time of 10s were entered, the relative dimming would take 10s from 0 to 100% and vice versa. Relative dimming by 50% would take 5s.

- **Dimming speed for absolute dimming**
Defines the time for all absolute dimming processes related to an absolute dimming process of 100%. If a time of 10s were entered, absolute dimming would take from 0 to 100% and vice versa 10s. Absolute dimming by 50% would take 5s.

5.3.3.4 Switch-on/off behaviour

The following figure shows the available settings for the switch-on behavior:

Delays:	
Switching on delay	no delay ▼ s
Switching off delay	no delay ▼ s
Switching on behavior at day	last value / sequence ▼
Switching on speed at day	2 ▲▼ s
Switching off speed at day	4 ▲▼ s
<hr/>	
Switching on behavior at night	last value / sequence ▼
Switching on speed at night	2 ▲▼ s
Switching off speed at night	2 ▲▼ s

Figure 37: Settings – Switch on/off behaviour

The switch-on behaviour can be set separately for day and night. Both the respective switch-on behaviour and the specific switch-on/switch-off speeds can be defined.

The following switch-on behaviour can be parameterised:

- **Last value/sequence**
The value before switching off is restored or the sequence which was active before switching off is started.
- **fixed RGB/RGBW values**
Fixed RGB/RGBW values are dimmed.
- **fixed HSV values**
Fixed HSV values are dimmed.
- **Start sequence 1-6**
Sequence 1-6 will be started.
- **Start HCL**
HCL will be started.

The set times have the following effects:

- **Switch on behaviour**
The switch-on delay defines the time between the switch-on pulse and the first dimming of the respective channel.
- **Switch off behaviour**
The switch-off delay defines the time between the switch-off pulse and the first dimming of the respective channel.

- Switch on speed**
 A soft-start function is realized by the switch-on speed. The switch-on time refers only to the "hard" switch-on, e.g. after a reset or via the object "LED RGB/RGBW switching" and not to the dimming up of 0%. With a switch-on time of 2s, the RGB LED is slowly dimmed to the set value within 2s.
- Switch off speed**
 A soft-stop function is realized by the switch-off speed. The switch-off time refers only to the "hard" switch-off, e.g. via the object "LED RGB/RGBW switching" and not to the dimming down to 0%. With a switch-off time of 2s, the RGB LED is dimmed to 0% within 2s.

5.3.3.5 Switch-on with.../switch-off with ...

The following figure shows the setting options for the switch-on/switch-off behaviour:

Switch on Hue (H) with relative dimming	<input type="radio"/> not active	<input checked="" type="radio"/> active
Switch on Saturation (S) with relative dimming	<input type="radio"/> not active	<input checked="" type="radio"/> active
Switch off with relative dimming Brightness (V) (Obj. 73,79)	<input type="radio"/> not active	<input checked="" type="radio"/> active
Switch on Color temperature with relative dimming	<input type="radio"/> not active	<input checked="" type="radio"/> active
Switch on with absolute value of Hue/ Saturation	<input type="radio"/> not active	<input checked="" type="radio"/> active

Figure 38: Settings – Switch on/off behaviour 2

The parameters have the following effects:

- Switch on Hue (H) with relative dimming**
 The channel is switched on with the relative dimming of the colour tone. If this parameter is not active, relative dimming of the hue would have no effect when switched off.
- Switch on Saturation (S) with relative dimming**
 The channel is switched on with the relative dimming of the colour saturation. If this parameter is not active, relative dimming of the colour saturation would have no effect when switched off.
- Switch off with relative dimming Brightness (V)**
 This parameter can be used to set whether the channel can be switched off via relative dimming. If this parameter is set to not active, the channel dims via relative dimming only up to the set minimum value and does not switch off the channel.
- Switch on Color temperature with relative dimming**
 The channel is switched on with the relative dimming of the colour temperature. If this parameter is not active, relative dimming of the colour temperature would have no effect when switched off. Only for Tunable White via RGB/RGBW.
- Switch on with absolute value of Hue/Saturation**
 Setting whether the channel should be switched on with an absolute dimming command for hue/saturation. If this parameter is not active, absolute dimming of the hue/saturation would not switch on the channel.

5.3.3.6 Behaviour after Reset

The following figure shows the possible settings for the behaviour after a reset:

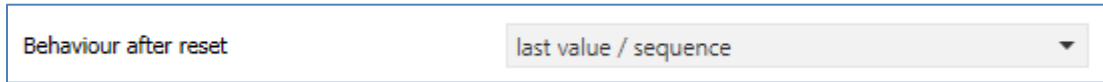

Figure 39: Setting – Behaviour after Reset

The following settings are available:

- **Deactivation**
The channel is switched off after a reset.
- **Activation value Day/Night**
The switch-on value for day or night is called up.
- **Last value/sequence**
The value before the reset is restored or the sequence which was active before the reset is started.
- **Fixed RGB/RGBW values**
Fixed RGB/RGBW values are dimmed.
- **Fixed HSV values**
Fixed HSV values are dimmed.
- **Fixed TW values**
Fixed Tunable White values are dimmed. Only if Tunable White is active via RGB/RGBW.
- **Start sequence 1-6**
It is started with sequence 1-6.
- **Start HCL**
HCL is started.

5.3.3.7 Staircase light

The following figure shows the available settings for the staircase lighting function:

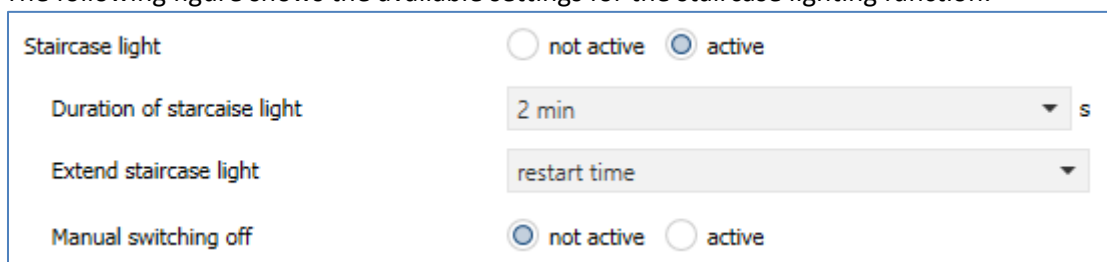

Figure 40: Settings – Staircase light

The following table shows the setting options for the staircase lighting function:

ETS-Text	Dynamic range [Default value]	Comment
Duration of staircase light	No delay, 1s,5s,10s,15s,20s,30s,45s,60s 2/3/4/5/6/7/8/9/10/15/20/30/ 45/60/90/120/180/240min	Duration of the staircase time. Sets the time of how long light is switch-on
Extend staircase light	<ul style="list-style-type: none"> • not active • restart time • add up time 	Allows a possible extension of the staircase light time
Manual switching off	<ul style="list-style-type: none"> • not active • active 	Allows to switch-off manually before the staircase lighting time has elapsed

Table 45: Settings – Staircase light

The staircase lighting function switches on the RGB/RGBW LEDs with the settings for the day/night switch-on behaviour for the set staircase lighting duration.

The "**Extend staircase light**" parameter can be used to activate that a new ON telegram either restarts the staircase lighting time from 0s or extends the currently running staircase lighting time by the staircase lighting duration. With the latter setting, the staircase timer can be extended as required.

The "**Manual switch-off**" parameter can be used to define whether an OFF telegram causes the channel to be switched off or whether an OFF telegram is ignored and the channel is only switched off after the staircase timer has elapsed.

If the staircase lighting function is activated, a new "Staircase lighting" communication object appears in addition to the Switching object:

Number	Name	Length	Usage
65	Staircase light	1 Bit	Switches on the staircase time

Table 46: Communication object – Staircase light

5.3.4 RGB/RGBW Block and Force Functions

The blocking function blocks the RGB/RGBW LED for further operation and can call up additional defined states. The following figure shows the parameters for the disable process:

Block object 1 - datapoint type	1Bit Object
Action at object value = 1	<input checked="" type="radio"/> block <input type="radio"/> unblock/enable
Action at object value = 0	unblock/enable
Action at locking	fixed HSV-values
Hue (H)	0° (Red)
Saturation (S)	100%
Brightness (V)	100%
<hr/>	
Action at unlocking	hold value / no change
Dimming speed	2 s
Release time (0s=not active)	0 s
<hr/>	
Block object 2 - datapoint type	not active

Figure 41: Settings – Block and Force functions (RGB/RGBW)

Each channel has 2 independent blocking functions, whereby blocking function 1 has a higher priority than blocking function 2.

Each block function can be activated/ deactivated by a 1 Bit object, a 2 Bit object or a 1 Byte object.

The following table shows the available setting options for the various blocks:

ETS-Text	Dynamic range [Default value]	Comment
Block object 1/2 – Data point type	<ul style="list-style-type: none"> • not active • 1 Bit Objekt • 2 Bit Object • 1 Byte dimming value 	Selection of whether the blocking object is active and, if so, with which datapoint type it is to be executed
Selection: via 1 Bit object		
Block object 1/2 – Data point type	<ul style="list-style-type: none"> • 1 Bit Object 	Selection of the data point type for the lock object
Action at object value = 1	<ul style="list-style-type: none"> • block • unblock/enable 	Setting whether value 1 is to be locked or unlocked
Action at object value = 0	is determined automatically after selection of the action with object value = 1	Setting whether to lock or unlock at value 0; is automatically defined by action at value = 1
Selection: via 2 Bit object		
Block object 1/2 – Data point type	<ul style="list-style-type: none"> • 2 Bit Object 	Selection of the data point type for the lock object
Action at object value Force ON	block	With object value Force ON, the channel is always blocked. Not adjustable
Action at object value Force OFF	<ul style="list-style-type: none"> • Block -> Off • No change 	Setting of the action to be performed in case of force OFF
Action at object value Force End	unlock/enable	With object value Force end, the channel is always unlocked. Not adjustable
Selection: via 1 Byte object		
Block object 1/2 – Data point type	<ul style="list-style-type: none"> • 1 Byte Object 	Selection of the data point type for the lock object
Action at dimming value = 0%	unlock/enable	With object value 0%, the channel is always unlocked. Not adjustable

Block object 1/2 -> Action at locking/ unlocking	<ul style="list-style-type: none"> • Deactivation • Activation value (Day/Night) • Hold value/no change • Value before locking • fixed RGB/RGBW values • fixed HSV values • HSV – change Hue • HSV – change Saturation • HSV – change Brightness • fixed TW values • TW – change Hue • TW – change Brightness • Start Sequence 1-6 • Start HCL • Stop Sequence 	Setting the action at locking / unlocking
Dimming speed	0 ... 120 s [2s]	Setting the dimming speed for calling up a brightness value
Release time (0 = not active)	0 ... 32000 s [0s]	Setting whether the disable function is automatically reset after a defined time.

Table 47: Settings – Block and Force functions (RGB/RGBW)

Disable functions 1 and 2 can be triggered with 3 different data point types. The behavior is then as follows:

- **1 Bit Object**
It can be freely defined whether the channel with the "0" or the "1" is to be locked/unlocked. The actions for locking/unlocking can also be set.
- **2 Bit Object**
By means of 2 bit forced control, the channel is blocked with object value Force ON (11). The channel is unlocked with object value Forced end (00). The action for Forced Off (10) can be set to "Block -> Off" or "No change".
- **1 Byte Objekt**
The channel is set to the corresponding value via a dimming value >0% by means of 1 byte object (it can be specified whether the colour temperature, saturation or brightness is to be changed for HSV and the colour temperature or brightness is to be changed for Tunable White) and disabled. The value 0% unlocks the channel again.

The following actions can be set for locking and unlocking:

- **Deactivation**
The channel is switched off.
- **Activation value (Day/Night)**
The channel is set to the currently valid switch-on value (depending on whether it is day or night).
- **Hold value / no change**
The channel remains in its current state.
- **Value before locking**
The channel restores the value it had before the disable function.
- **fixed RGB/RGBW values**
A freely adjustable RGB/RGBW value is controlled.
- **fixed HSV values**
A freely adjustable HSV value is controlled.
- **HSV – change Hue**
Only the hue is set to a freely adjustable value. Color saturation and brightness remain at their current value.
- **HSV – change Saturation**
Only the color saturation is set to a freely adjustable value. Hue and brightness remain at their current value.
- **HSV – change Brightness**
Only the brightness is set to a freely adjustable value. Hue and color saturation remain at their current value.
- **fixed TW values**
A freely adjustable Tunable White value is controlled.
- **TW – change color temperature**
Only the color temperature is set to a freely adjustable value. The brightness remains at its current value.
- **TW – change Brightness**
Only the brightness is set to a freely adjustable value. The color temperature remains at its current value.
- **Start sequence 1-6**
The respective sequence is started.
- **Start HCL**
HCL is started.
- **Stop sequence**
All active sequences are stopped.

The following table shows the corresponding communication objects:

Number	Name	Length	Usage
94	Block 1	1 Bit 2 Bit 1 Byte	Block object 1, type depends on the data point settings for the first block object
95	Block 2	1 Bit 2 Bit 1 Byte	Block object 2, type depends on the data point settings for the second block object
96	Block state	1 Bit	Transmits a 1 if channel is locked and a 0 if channel is not locked

Table 48: Communication objects – Block functions

5.3.5 LED RGB/RGBW Bit Scenes

The following picture shows the available settings for the bit scenes:

Bit Scene 1	<input type="radio"/> not active <input checked="" type="radio"/> active
Description	<input type="text"/>
Action at value = 1	fixed HSV-values ▼
Hue (H) Bit value 1	0° (Red) ▼
Saturation (S) Bit value 1	100% ▼
Brightness (V) Bit value 1	100% ▼
Action at value = 0	deactivation ▼
Dimming speed	<input type="text" value="0"/> s
Bit Scene 2	<input checked="" type="radio"/> not active <input type="radio"/> active
Bit Scene 3	<input checked="" type="radio"/> not active <input type="radio"/> active
Bit Scene 4	<input checked="" type="radio"/> not active <input type="radio"/> active

Figure 42: Settings – Bit Scenes (RGB/RGBW)

The functionality of the bit scenes is analogous to that of the normal scene function, only that an action can be triggered for both the value 0 and the value 1. The bit scenes can be triggered via simple switching functions.

The following settings are available for an activated bit scene:

ETS-Text	Dynamic range [Default value]	Comment
Description	Freely selectable name	For identification of the bit scene; name is also adopted in the communication objects
Action at value = 1/ value = 0	<ul style="list-style-type: none"> • Deactivation • Activation value (Day/Night) • Hold value/no change • fixed RGB/RGBW values • fixed HSV values • HSV – change Hue • HSV – change Saturation • HSV – change Brightness • fixed TW values • TW – change Hue • TW – change Brightness • Start Sequence 1-6 • Start HCL • Stop Sequence • Enable Block 1 • Enable Block 2 • Unlocking 	Setting for the reception of the value 0/1 on the bit scene object
Dimming speed	0-14400s [0s]	Setting the dimming speed for calling up scenes

Table 49: Settings – Bit Scenes (RGB/RGBW)

The following actions can be defined for the value 0 and 1 of the bit scenes:

- **Deactivation**
The channel is switched off.
- **Activation value (Day/Night)**
The channel is set to the currently valid switch-on value (depending on whether it is day or night).
- **Hold value / no change**
The channel remains in its current state.
- **fixed RGB/RGBW values**
A freely adjustable RGB/RGBW value is controlled.
- **fixed HSV values**
A freely adjustable HSV value is controlled.
- **HSV – change Hue**
Only the hue is set to a freely adjustable value. Color saturation and brightness remain at their current value.
- **HSV – change Saturation**
Only the color saturation is set to a freely adjustable value. Hue and brightness remain at their current value.
- **HSV – change Brightness**
Only the brightness is set to a freely adjustable value. Hue and color saturation remain at their current value.

- **fixed TW values**
A freely adjustable Tunable White value is controlled.
- **TW – change color temperature**
Only the color temperature is set to a freely adjustable value. The brightness remains at its current value.
- **TW – change Brightness**
Only the brightness is set to a freely adjustable value. The color temperature remains at its current value.
- **Start sequence 1-6**
The respective sequence is started.
- **Start HCL**
HCL is started.
- **Stop sequence**
All active sequences are stopped.
- **Enable Block 1/2**
Block 1/2 is activated.
- **Unlocking**
The LED controller is unlocked.

The following table shows the corresponding communication objects:

Number	Name	Length	Usage
90	Start Bit Scene 1	1 Bit	Call up of Bit Scene 1
91	Start Bit Scene 2	1 Bit	Call up of Bit Scene 2
92	Start Bit Scene 3	1 Bit	Call up of Bit Scene 3
93	Start Bit Scene 4	1 Bit	Call up of Bit Scene 4

Table 50: Communication objects – Bit Scenes (RGB/RGBW)

5.3.6 LED RGB/RGBW Scenes

Up to 8 scenes can be programmed which can be assigned to one of the 64 possible scene numbers. The following picture shows the possible settings in the submenu LED RGB/W Scene:

Save scene	not active
Scene number A	1
Action	fixed HSV-values
Hue (H)	0° (Red)
Saturation (S)	100%
Brightness (V)	100%
Dimming speed	1 s
Scene number B	not active
Scene number C	not active
Scene number D	not active
Scene number E	not active
Scene number F	not active
Scene number G	not active
Scene number H	not active

Figure 43: Settings – Scenes (RGB/RGBW)

The following table shows the setting options for an activated scene function:

ETS-Text	Dynamic range [Default value]	Comment
Save scene	<ul style="list-style-type: none"> • not active • active • Keep learned scene (no takeover of parameter) 	Setting whether the current value of the scene can be saved (only for fixed values) and whether the value is reset after reprogramming. Save scene active: Saved value is reset after reprogramming. Keep learned scene: Stored value is retained after reprogramming
Scene number A-H	not active 1 – 64	Setting the scene number for scene recall
Action	<ul style="list-style-type: none"> • Deactivation • Activation value (Day/Night) • fixed RGB/RGBW values • fixed HSV values • HSV – change Hue • HSV – change Saturation • HSV – change Brightness • fixed TW values • TW – change Hue • TW – change Brightness • Start Sequence 1-6 • Start HCL • Stop Sequence • Enable Block 1 • Enable Block 2 • Unlocking 	Setting the action for scene recall
Dimming speed	0 ... 14400 s [1 s]	Setting the dimming speed for calling up scenes

Table 51: Settings – Scenes (RGB/RGBW)

The scenes can be called up using the following communication object:

Number	Name	Length	Usage
89	Scene	1 Byte	Call up of scenes

Table 52: Communication object – Scenes (RGB/RGBW)

The communication object for the scenes is only displayed if they are activated.

The following actions can be defined for calling up the scenes:

- **Deactivation**
The channel is switched off.
- **Activation value (Day/Night)**
The channel is set to the currently valid switch-on value (depending on whether it is day or night).
- **fixed RGB/RGBW values**
A freely adjustable RGB/RGBW value is controlled.
- **fixed HSV values**
A freely adjustable HSV value is controlled.
- **HSV – change Hue**
Only the hue is set to a freely adjustable value. Color saturation and brightness remain at their current value.
- **HSV – change Saturation**
Only the color saturation is set to a freely adjustable value. Hue and brightness remain at their current value.
- **HSV – change Brightness**
Only the brightness is set to a freely adjustable value. Hue and color saturation remain at their current value.
- **fixed TW values**
A freely adjustable Tunable White value is controlled.
- **TW – change color temperature**
Only the color temperature is set to a freely adjustable value. The brightness remains at its current value.
- **TW – change Brightness**
Only the brightness is set to a freely adjustable value. The color temperature remains at its current value.
- **Start sequence 1-6**
The respective sequence is started.
- **Start HCL**
HCL is started.
- **Stop sequence**
All active sequences are stopped.
- **Enable Block 1/2**
Block 1/2 is activated.
- **Unlocking**
The LED controller is unlocked.

To call up a scene or save a new value for the scene, the corresponding code is sent to the corresponding communication object for the scene:

Scene	Call		Save	
	Hex.	Dec.	Hex.	Hex.
1	0x00	0	0x80	128
2	0x01	1	0x81	129
3	0x02	2	0x82	130
4	0x03	3	0x83	131
5	0x04	4	0x84	132
6	0x05	5	0x85	133
7	0x06	6	0x86	134
8	0x07	7	0x87	135
9	0x08	8	0x88	136
10	0x09	9	0x89	137
11	0x0A	10	0x8A	138
12	0x0B	11	0x8B	139
13	0x0C	12	0x8C	140
14	0x0D	13	0x8D	141
15	0x0E	14	0x8E	142
16	0x0F	15	0x8F	143
17	0x10	16	0x90	144
18	0x11	17	0x91	145
19	0x12	18	0x92	146
20	0x13	19	0x93	147
21	0x14	20	0x94	148
22	0x15	21	0x95	149
23	0x16	22	0x96	150
24	0x17	23	0x97	151
25	0x18	24	0x98	152
26	0x19	25	0x99	153
27	0x1A	26	0x9A	154
28	0x1B	27	0x9B	155
29	0x1C	28	0x9C	156
30	0x1D	29	0x9D	157
31	0x1E	30	0x9E	158
32	0x1F	31	0x9F	159
....
64	0x3f	63	0xBF	191

Table 53: Codes for calling and saving scenes

5.3.7 LED RGB/RGBW Sequences

You can set up to 6 sequences in RGBW mode and up to 4 sequences in RGB mode. These can be set with either predefined or custom sequences. The following picture shows the activation of the individual sequences:

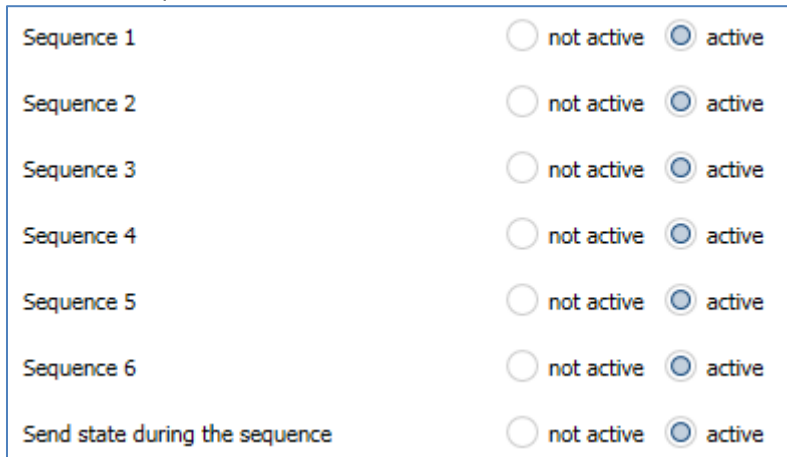

Figure 44: Settings – Activation of sequences

For each activated sequence, a submenu is displayed in which the corresponding sequence can be set.

In addition, a communication object for starting and stopping the sequence is displayed for each activated sequence:

Number	Name	Length	Usage
119	Start Sequence 1	1 Bit	1 = Start Sequence 1; 0 = Stop Sequence 1
120	Sequence 1 State	1 Bit	1 = Sequence is active; 0 = Sequence not active
121	Start Sequence 2	1 Bit	1 = Start Sequence 2; 0 = Stop Sequence 2
122	Sequence 2 State	1 Bit	1 = Sequence is active; 0 = Sequence not active
123	Start Sequence 3	1 Bit	1 = Start Sequence 3; 0 = Stop Sequence 3
124	Sequence 3 State	1 Bit	1 = Sequence is active; 0 = Sequence not active
125	Start Sequence 4	1 Bit	1 = Start Sequence 4; 0 = Stop Sequence 4
126	Sequence 4 State	1 Bit	1 = Sequence is active; 0 = Sequence not active
127	Start Sequence 5	1 Bit	1 = Start Sequence 5; 0 = Stop Sequence 5
128	Sequence 5 State	1 Bit	1 = Sequence is active; 0 = Sequence not active
129	Start Sequence 6	1 Bit	1 = Start Sequence 6; 0 = Stop Sequence 6
130	Sequence 6 State	1 Bit	1 = Sequence is active; 0 = Sequence not active

Table 54: Communication objects – Sequences (RGB/RGBW)

The parameter "**Send status during sequence**" activates the status output during a sequence. The status is output in the color space that is currently being dimmed. If the sequence runs in the HSV color space, the LED controller outputs the status on the HSV objects.

5.3.7.1 Sequences – General settings

The following settings are available for all types of sequences:

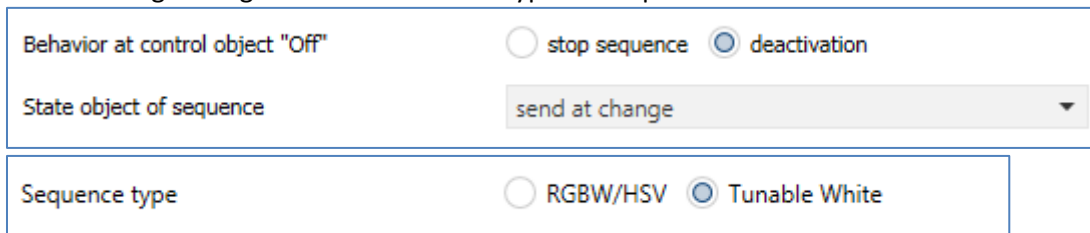

Figure 45: General settings – Sequences (RGB/RGBW)

The following settings are available:

- Behaviour at control object „Off“**
 This parameter defines whether the RGB/RGBW LEDs are switched off completely or only the sequence is stopped when the sequence is switched off.
- State object of sequence**
 This parameter defines the transmission behavior of the status object for the sequence. The setting "send on change" determines that the status is sent on each change. The setting "Send on change and restart" causes the status to be sent with each change and additionally after each run of a sequence.
- Sequence type (only visible when Tunable White via RGBW is activated)**
 The sequence type can be selected between RGBW/HSV and Tunable White. Changing the sequence type also changes the possible sequences.

5.3.4.1 Sequences via relative dimming

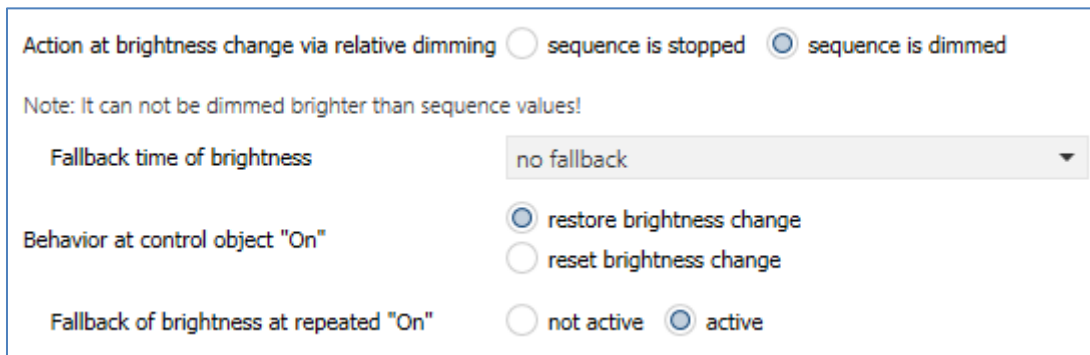

Figure 46: Settings – Sequences via relative dimming

Sequences can also be dimmed down using relative dimming commands (setting: "Action on brightness change via relative dimming - sequence is dimmed"). It can only be dimmed down, but not above the set values. With relative dimming, the brightness values of the calibration points are then adjusted according to the dimming command: If, for example, dimming is reduced by 50%, all brightness values are reduced by 50% (30% -> 15%, 50% ->25%, etc.).

For relative dimming, there are several ways to reset the brightness change:

- Fallback time of brightness**
 The brightness is automatically reset to the parameter value after a set time.

- **Behaviour at control object „On“**
The brightness can be restored with the dimmed value when the sequence is restarted via the "Restore brightness change" setting. The "Reset brightness change" setting resets the brightness to the set value from the parameters.
- **Fallback of brightness at repeated „On“**
The brightness is reset to the parameter value when two On commands are sent one after the other to the control object (start sequence).

If the parameter value is to be used for dimming upwards, the parameter "Keep HCL/sequences active" must be set to active. Now the channel can be dimmed upwards at any time and remains there until the next interpolation point is reached. From this point on, the channel synchronizes again with time-dependent dimming until the next interpolation point is reached.

5.3.7.2 Predefined sequences (only with sequence type RGBW/HSV)

If the following parameter is selected, a series of predefined sequences are available:

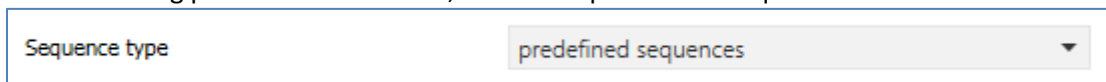

Figure 47: Setting – Activation of predefined sequences (RGB/RGBW)

The following sequences can be selected:

- **Colorful**
The sequence "Colorful" comprises 3 steps with the transition points red, green, blue and runs through the colors in the entire color circle. The sequence is an endless loop.
The sequence has the following parameters:
Saturation (S): Indicates the saturation of the passing colors (see 5.2 Color wheel display/ RGBW control).
Brightness (V): Indicates the brightness of the passing colors (see 5.2 Color wheel display/ RGBW control)
Transition time to step 1: Specifies the time required for the transition from red to green.
Transition time to step 2: Specifies the time required for the transition from green to blue.
Transition time to step 3: Specifies the time required for the transition from blue back to red
- **Warm Colors**
The sequence "Warm colors" comprises 3 steps and runs through the colors red->orange->yellow, i.e. the first quarter of the color circle. This is an endless loop.
The sequence has the following parameters:
Saturation (S): Indicates the saturation of the passing colors (see 5.2 Color wheel display/ RGBW control).
Brightness (V): Indicates the brightness of the passing colors (see 5.2 Color wheel display/ RGBW control)
Transition time to step 1: Specifies the time required for the transition from red to orange.
Transition time to step 2: Specifies the time required for the transition from orange to yellow.
Transition time to step 3: Specifies the time required for the transition from yellow back to red (starting point).

- **Cold Colors**
 the sequence "Cold colours" comprises 4 steps and runs through the colours aquamarine-green->turquoise->mint->blue. Thus the lower, cold part of the color circle is passed through. The sequence has the following parameters:
Saturation (S): Indicates the saturation of the passing colors (see 5.2 Color wheel display/ RGBW control).
Brightness (V): Indicates the brightness of the passing colors (see 5.2 Color wheel display/ RGBW control)
Transition time to step 1: Specifies the time required for the transition from Aquamarine-green to Turquoise.
Transition time to step 2: Specifies the time required for the transition from Tuquoise to Mint.
Transition time to step 3: Specifies the time required for the transition from Mint to Blau.
Transition time to step 4: Specifies the time required for the transition from Blue back to Aquamarine-green.

- **TV Simulation / Presence simulation**
 The "TV simulator/presence simulator" is an endless loop, which is completely constructed with random values. This means that the called colors as well as the transition and hold times are completely random. This sequence is intended to simulate the picture changes in a television set.

- **Sunrise**
 The sequence "Sunrise" dims from the switched off state in the steps Red with weak brightness->Red with stronger brightness->Orange->Yellow high. Thus the sunrise from the early morning red to the sunrise is simulated. The sequence "Sunrise" is a one-time sequence which is not repeated.
 The length of the sunrise can be set via the parameters „Transition times“.

- **Lounge random**
 The sequence "Lounge" runs through the whole color space from 0-360° with medium saturation. This is an endless loop.
 The sequence has the following parameters:
Brightness V: Specifies the brightness with which the color is to be called up when switching on (see 5.2 Color wheel display/ RGBW control).
Transition time [s]: Specifies the transition time between the steps.
Hold time (x100ms): Specifies the hold time of the respective steps in multiples of 100ms.

- **Indicate HSV**

The sequence "Indicate HSV" switches back and forth between 2 freely configurable colours. This is an endless loop.

The sequence has the following parameters:

For „On-values“:

Hue H: Specifies the color value that is to be called up when the device is switched on (see 5.2 Color wheel display/ RGBW control).

Saturation S: Specifies the saturation with which the color is to be called up when the device is switched on (see 5.2 Color wheel display/ RGBW control).

Brightness V: Specifies the brightness with which the color is to be called up when the device is switched on (see 5.2 Color wheel display/ RGBW control)).

Period in 100ms: Specifies the time how long the color should be called.

The same parameters exist for the „Off values“.

5.3.7.3 Manual sequences RGBW/HSV

For the manual sequences there are 2 selection options. On the one hand the manual sequences can be set via RGB/RGBW and on the other hand via HSV. However, the setting options are basically the same, only the display of colors and values is different.

The following basic settings can be made:

Transition of sequence	<input checked="" type="radio"/> fixed transition period <input type="radio"/> times
Switch sequence with	<input checked="" type="radio"/> fixed values <input type="radio"/> random values
Endless loop	<input checked="" type="radio"/> not active <input type="radio"/> active
Number of execution	<input type="text" value="1"/>
Behavior after sequence	<input type="text" value="hold values"/>
Number of parameter steps	<input type="text" value="5"/>

Figure 48: General settings – Manual sequences (RGBW/HSV)

The following table shows the possible settings:

ETS-Text	Dynamic range [Default value]	Comment
Transition of sequence	<ul style="list-style-type: none"> • Fixed transition period • Times 	Specifies whether the transition from one step to the next is to take place after a fixed time or at a specific time
Switch sequence with	<ul style="list-style-type: none"> • Fixed values • Random values 	The parameter specifies whether the colors for the individual steps are to be fixed or random values are to be generated. In addition, it is possible to switch the sequence according to fixed times
Random transition time	<ul style="list-style-type: none"> • not active • active 	indicates whether the time between two steps should be random or should have a fixed value; only available with Switch sequence with: Random values
Endless loop	<ul style="list-style-type: none"> • not active • active 	defines whether the sequence is to run in an endless loop
Number of executions	1-255 [1]	Only displayed if "endless loop" -> "not active". Parameter indicates the number of sequence executions.
Behaviour after sequence	<ul style="list-style-type: none"> • Deactivation • Hold values • Start sequence 1-6 	Only displayed if "endless loop" -> "not active". Parameter specifies the behavior after the current sequence has been executed.
Number of parameter steps	1-5 [5]	Defines the number of steps in this sequence

Table 55: General settings – Manual sequences (RGBW/HSV)

Sequence with fixed values:

If the sequence is controlled with fixed values, certain values are entered for each step which are to be called in this step. The following figure shows the possible settings for the sequence with fixed values for HSV control:

Step 1	
Hue (H)	0° (Red)
Saturation (S)	100%
Brightness (V)	100%
Hold time	5 x100 ms
Transition time to the next step	10 s

Figure 49: Settings – Manual sequence with fixed values

As you can see in the picture above, a defined color can be approached for each step. In addition, it is possible to adjust the saturation and brightness of the HSV control. The hold time indicates how long a step is to be executed or the sequence is to remain in this state. The transition time defines the time in which a step is to be dimmed to the next one.

Sequence with random values:

If the sequence is switched with random values, the values are generated randomly by the device. However, it is possible to limit the value ranges from which the random values are to be generated. The following picture shows the possible settings for the sequence with random values with RGBW control:

Step 1	
Lower limit Hue Red	0%
Upper limit Hue Red	100%
Lower limit Hue Green	0%
Upper limit Hue Green	100%
Lower limit Hue Blue	0%
Upper limit Hue Blue	100%
Lower limit Hue White	0%
Upper limit Hue White	100%
Hold time	5 x100 ms
Transition time to the next step	10 s

Figure 50: Settings – Manual sequence with random values

As you can see in the picture above, each color can be limited. This also applies to control via HSV. Here, however, the values for H, S and V are limited. The hold time indicates how long a step is to be executed or the sequence is to remain in this state.

The transition time can also be changed here between random or fixed value:



Figure 51: Setting – Random transition time

With a random transition time, the transition time can also be limited to a fixed value so that the dimming control unit selects a value between 0 and the parameterised value. The following parameter is displayed for random transition times:

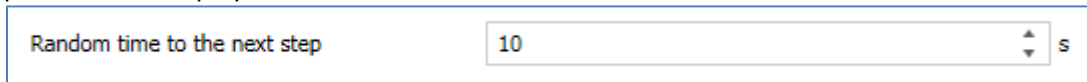

Figure 52: Setting – Random time to next step

If the parameter "Random transition time" is set to inactive, a fixed value can be entered for the transition time.

The transition time defines the time in which the dimming should take place from one step to the next.

Numbers of loops

The number of loop passes can be defined with the following settings:

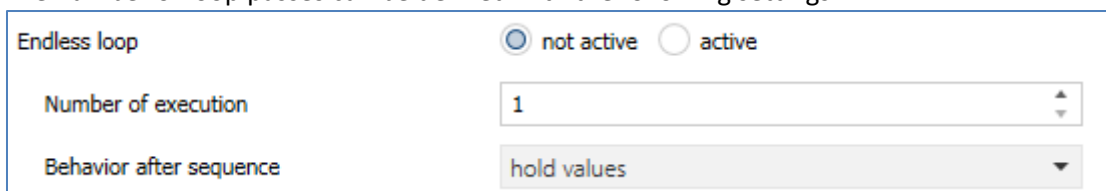

Figure 53: Settings – Endless loop

If the sequence is defined as an endless loop, the sequence is run through until it is stopped again via the communication object for this sequence. In this case, the other parameters for setting the loop passes are omitted.

If the sequence is not defined as an endless loop, the number of executions can be defined. In addition, a behavior can be defined after the end of the sequence. After the end of the sequence the RGB/RGBW LEDs can be switched off or hold the last value. Also a following sequence can be defined.

For example, sequence 1 can be followed by sequence 2, which in turn calls the 3rd sequence. If this calls the first sequence again, an endless loop is created. Furthermore, this parameter can be used to extend a sequence by a maximum of 5 further steps.

5.3.8 Tunable White via RGBW

Tunable White via RGBW is only available for function selection Dim RGBW LED! Not for RGB LEDs.

Activation of the function in the "LED RGBW settings" menu:

Tunable White via RGBW setting not active active

Figure 54: Settings – Activation: Tunable White via RGBW

If Tunable White is activated via RGBW, the following submenu appears:

Color temperature of warm white Kelvin

Color temperature of cold white Kelvin

Color temperature for White (Channel D) warm white cold white

Composition of Cold White:

Channel A (Red level)	0%
Channel B (Green level)	0%
Channel C (Blue level)	0%
Channel D (White level)	100%

Composition of Warm White:

Channel A (Red level)	<input type="text" value="100%"/>
Channel B (Green level)	<input type="text" value="75%"/>
Channel C (Blue level)	<input type="text" value="50%"/>
Channel D (White level)	0%

Note: It can not be dimmed brighter than sequence values!

Brightness via different color temperatures constant maximum

Overload 100% brightness at relative dimming not active active

Automatic setting of color temperature none Dim2Warm (Brightness)

Figure 55: Settings – Tunable White via RGBW

Tunable White via RGBW is a theoretical conversion of RGBW values into Tunable White values. This requires well tuned RGBW LEDs and a good basic colour temperature setting for warm white. For Tunable White to achieve the best results with RGBW, the white channel should have the light colour cold white.

The following communication objects are additionally displayed with Tunable White:

Number	Name	Length	Usage
74	LED TW Color temperature (level of CW in %)	1 Byte	Specification of a new absolute proportion of cold white
75	LED TW Color temperature (Kelvin)	2 Byte	Specification of a new colour temperature in Kelvin
76	LED TW Brightness	1 Byte	Specification of a new absolute value for the brightness of Tunable White
77	LED TW transition (color temperature and brightness)	6 Byte	Control of brightness and color temperature
78	LED TW Color temperature (level in %)	4 Bit	Relative dimming of the cold white component
79	LED TW Brightness	4 Bit	Relative dimming of brightness

Table 56: Communication objects – Tunable White via RGBW

5.3.8.1 Basic settings

The following basic settings are available:

ETS-Text	Dynamic range [Default value]	Comment
Color temperature of Warm White	2000 ... 3300 K [2700 K]	Setting the colour temperature for Warm White
Color temperature of Cold White	4000 ... 8000 K [6000 K]	Setting the colour temperature for Cold White
Color temperature for White (Channel D)	<ul style="list-style-type: none"> • Warm White • Cold White 	Setting whether Cold or Warm White is connected to channel D
Composition of Cold White		
Channel A (Red-level)	0 – 100%	Adjustment at which color mixture Cold white is produced. The default values and setting options change depending on which color temperature is connected to channel D (setting color temperature for white)
Channel B (Green-level)	0 – 100%	
Channel C (Blue-level)	0 – 100%	
Channel D (White-level)	0 – 100%	
Composition of Warm White		
Channel A (Red-level)	0 – 100%	Adjustment of which colour mixture produces Warm White. The default values and setting options change depending on which colour temperature is connected to channel D (colour temperature setting for white)
Channel B (Green-level)	0 – 100%	
Channel C (Blue-level)	0 – 100%	
Channel D (White-level)	0 – 100%	
Brightness via different color temperatures	<ul style="list-style-type: none"> • constant • maximum 	Setting the calculation of the brightness for "100%"
100% Brightness override with relative dimming	<ul style="list-style-type: none"> • not active • active 	Setting whether the brightness can be overridden after reaching 100%

Table 57: Basic settings – Tunable White via RGBW

The colour temperature settings for Warm White/Cold White are used to set the dimming range of the colour temperature. For example, if the colour temperature of Warm White is set to 2700K and the colour temperature of Cold White to 6000K, the colour temperature can be changed from 2700K to 6000K.

The parameter Colour temperature for white (channel D) is used for RGBW LEDs to determine the light colour of the white channel of the LEDs.

Depending on this parameter, the available parameters for the composition of Warm White or Cold White are displayed. If, for example, an LED with cold white channel D is connected, the parameters for the composition of Warm White are displayed. The composition should be set so that a good Warm White/Cold White is produced.

The Brightness via different colour temperatures parameter defines the behaviour of brightness when the colour temperature is changed. The following settings are available:

- **constant**

If the colour temperature is changed, the brightness at the output remains constant. The following diagram shows the control of Warm White and Cold White at a set brightness level:

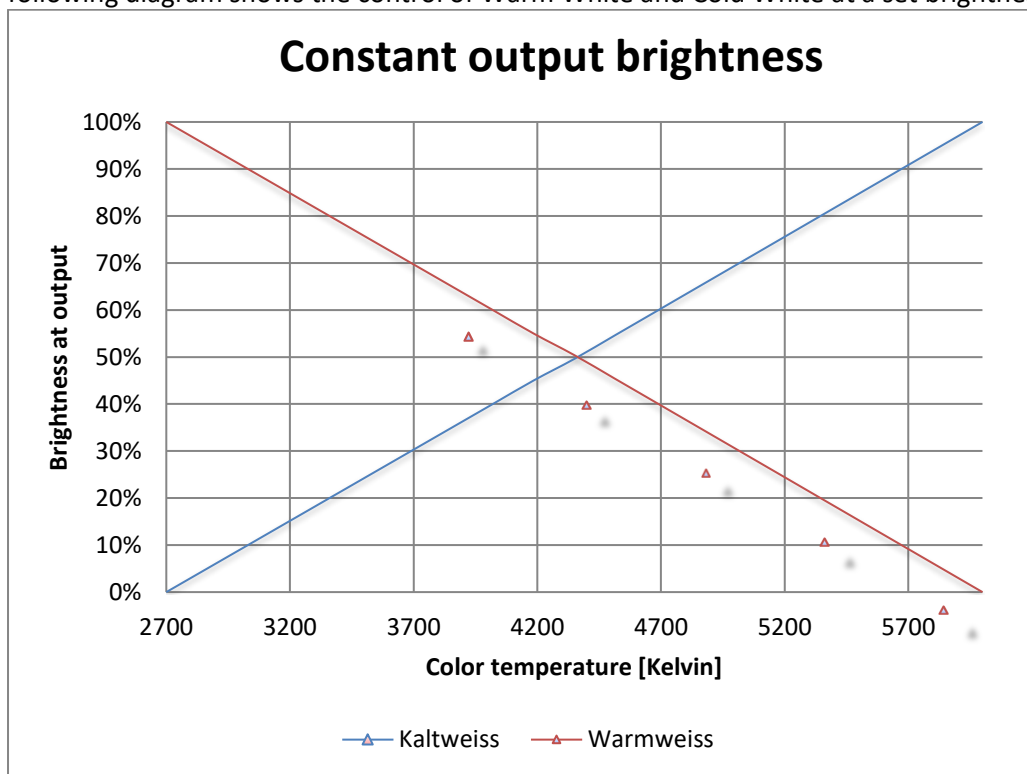

If the colour temperature is set to Warm White (2700K), Warm White has 100% output power. If the colour temperature is now shifted to Cold White, the output power of Warm White decreases and the output power of Cold White increases accordingly. The total output power remains constant over the entire range of the colour temperature change. This means that different values are approached with different dimming curves. For example, with a 50% Cold White component in the square dimming curve, the value 70% is approached, as this corresponds to a brightness of 50% at the output.

The parameter "Override 100% brightness with relative dimming" can be used to override the constant brightness upwards. For example, the colour temperature could be dimmed upwards with 50% Cold White and the value for Cold White and Warm White could be increased from 70% to up to 100%.

- **maximum**

The maximum setting sets the values for Warm White and Cold White to the maximum possible value. The following diagram shows the output power of Warm White and Cold White at a set brightness level:

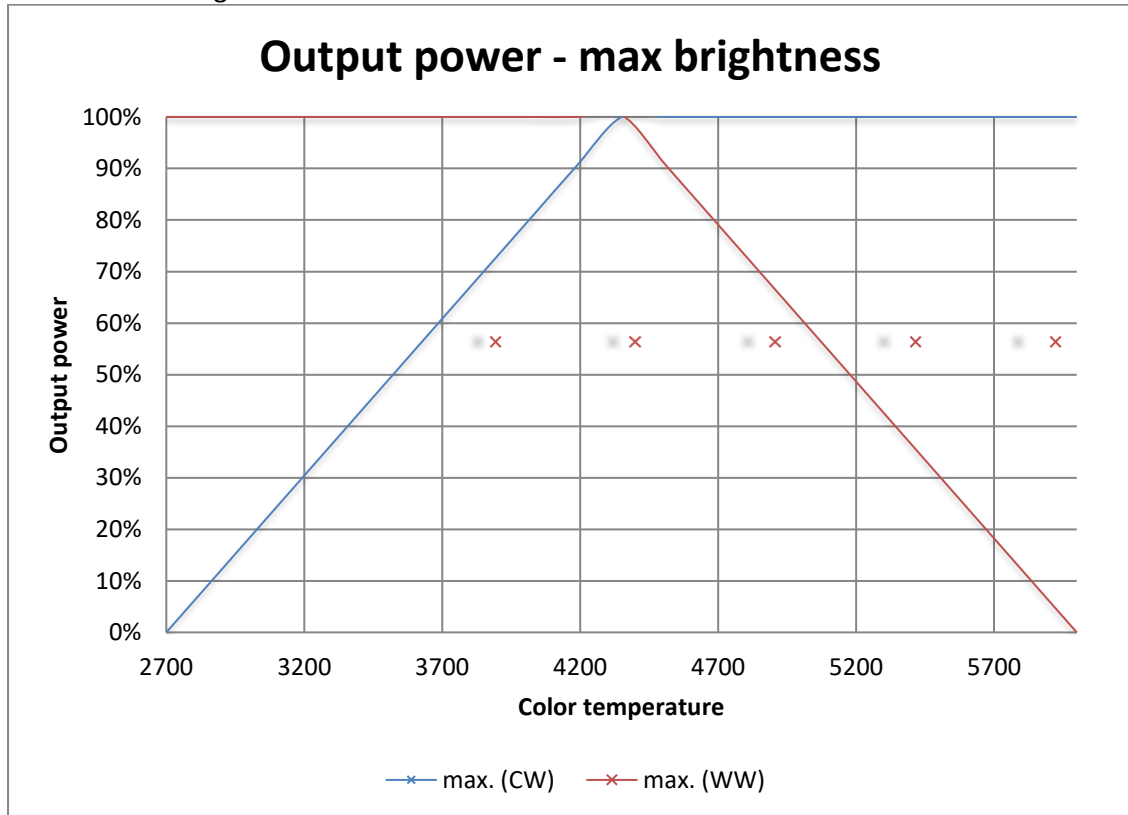

If the colour temperature is set to Warm White (2700K), Warm White has 100% output power and Cold White 0% output power. If the colour temperature is now shifted to cold white, the output power of Cold White increases without the output power of Warm White being reduced.

5.3.8.2 Dim2Warm

If Dim2Warm is activated, it is no longer possible to adjust the colour temperature manually, as this happens dynamically due to the change in brightness! The communication objects are hidden. The Dim2Warm function automatically adjusts the colour temperature when the brightness changes. The following figure shows the available settings:

Automatic setting of color temperature	<input type="radio"/> none <input checked="" type="radio"/> Dim2Warm (Brightness)
Control of Color temperature is valid	active for all dimming procedure ▼
Note: Preset color temperatures will be ignored when the coupling is activated.	
Color temperature, if lower than brightness threshold 1 (dark)	0% CW, 100% WW (warm +++) ▼
Brightness threshold 1 (dark)	0% ▼
Color temperature, if upper than brightness threshold 2 (bright)	100% CW, 0% WW (cold +++) ▼
Brightness threshold 2 (bright)	100% ▼

Figure 56: Settings – Dim2Warm

The Dim2Warm function automatically shifts the colour temperature to a warm colour temperature when the brightness is reduced. The following diagram shows the adjustment of the colour temperature for a warm colour temperature of 2700K and a cold colour temperature of 6000K and a Dim2Warm function activated with default settings (see Figure 56: Dim2Warm):

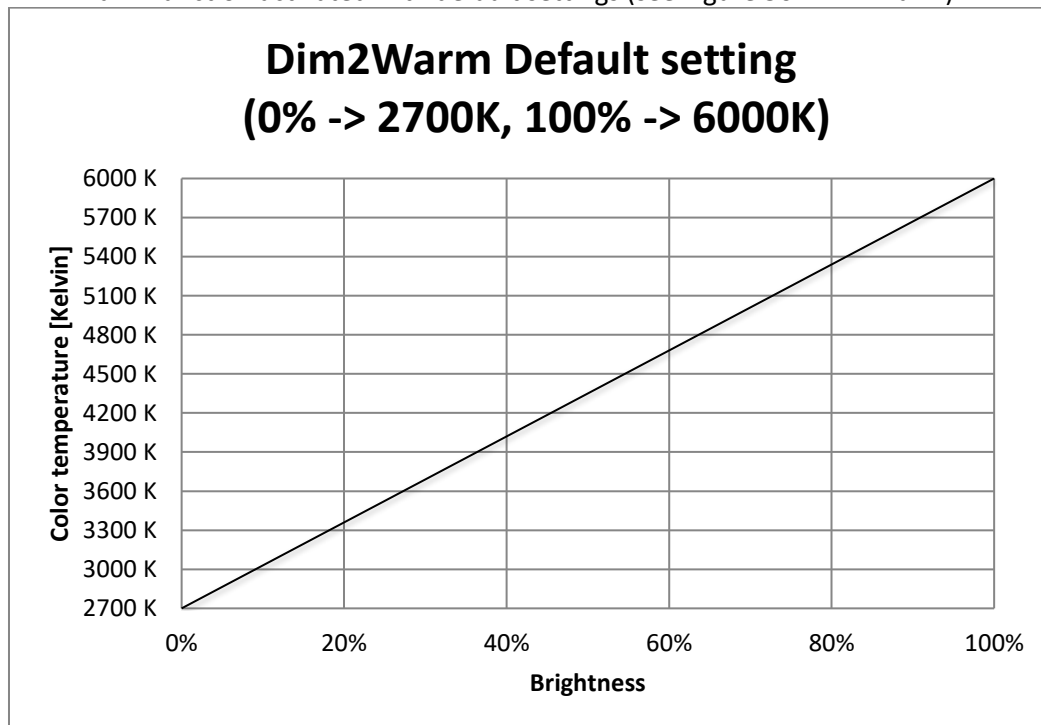

The Dim2Warm function shifts the color temperature in this example from 2700K at 0% brightness to 6000K at 100% brightness.

The following parameter settings are available for the Dim2Warm function:

ETS-Text	Dynamic range [Default value]	Comment
Automatic setting of color temperature	<ul style="list-style-type: none"> ▪ none ▪ Dim2Warm (Brightness) 	Activation of the „Dim2Warm“ function
With activation of “Dim2Warm” the following parameters appear:		
Control of Color temperature is valid	<ul style="list-style-type: none"> • active for all dimming procedures • active for relative- and absolute dimming procedures • active for switching On/Off of dimming procedures • active for switching on/off, relative and absolute dimming procedures 	Setting for which dimming processes Dim2Warm is active
Color temperature, if lower than brightness threshold 1 (dark)	<ul style="list-style-type: none"> • 0% CW, 100% WW • 5% CW, 95% WW • ... • 95% CW, 5% WW • 100% CW, 0% WW 	Setting which colour temperature is to be set below brightness threshold 1 during dimming
Brightness threshold 1 (dark)	0 – 45 % [0 %]	Setting from when the shift to warm color temperature takes effect
Color temperature when higher than Brightness threshold 2 (bright)	<ul style="list-style-type: none"> • 0% CW, 100% WW • 5% CW, 95% WW • ... • 95% CW, 5% WW • 100% CW, 0% WW 	Setting which colour temperature is to be set when dimming via the brightness threshold 2
Brightness threshold 1 (bright)	50 – 100 % [100 %]	Setting from when the shift to the cold colour temperature is active

Table 58: Settings – Dim2Warm

The parameter "**Control of colour temperature valid**" defines for which dimming processes the Dim2Warm function is to apply. The settings have the following effect:

- **active for all dimming procedures**
Dim 2 Warm is active for all dimming processes except sequences. This means that Dim2Warm is also executed when scenes, bit scenes or disable/force functions are called up.
- **active for relative- and absolute dimming procedures**
Dim2Warm is only active for dimming processes via the objects LED TW Brightness - Dimming Absolute and LED TW Brightness - Dimming Relative (objects 76 and 79).
- **active for switching On/Off of dimming procedures**
Dim2Warm is only active for on/off operations via the 1 Bit switching objects (64 and 65).
- **active for switching on/off, relative and absolute dimming procedures**
Dim2Warm is active for dimming processes via the objects LED TW Brightness - Dimming Absolute and LED TW Brightness - Dimming Relative and for switch-on/switch-off processes via the 1 Bit Switching object (objects 64, 65, 76 and 79). However, it is not active for calling scenes/bit scenes or disable/force functions or sequences.

If the Dim2Warm function is parameterised with the following settings:

Automatic setting of color temperature	<input type="radio"/> none <input checked="" type="radio"/> Dim2Warm (Brightness)
Control of Color temperature is valid	active for all dimming procedure
Note: Preset color temperatures will be ignored when the coupling is activated.	
Color temperature, if lower than brightness threshold 1 (dark)	0% CW, 100% WW (warm +++)
Brightness threshold 1 (dark)	20%
Color temperature, if upper than brightness threshold 2 (bright)	100% CW, 0% WW (cold +++)
Brightness threshold 2 (bright)	100%

Figure 57: Settings – Dim2Warm, Example 20%

This results in the following behavior:

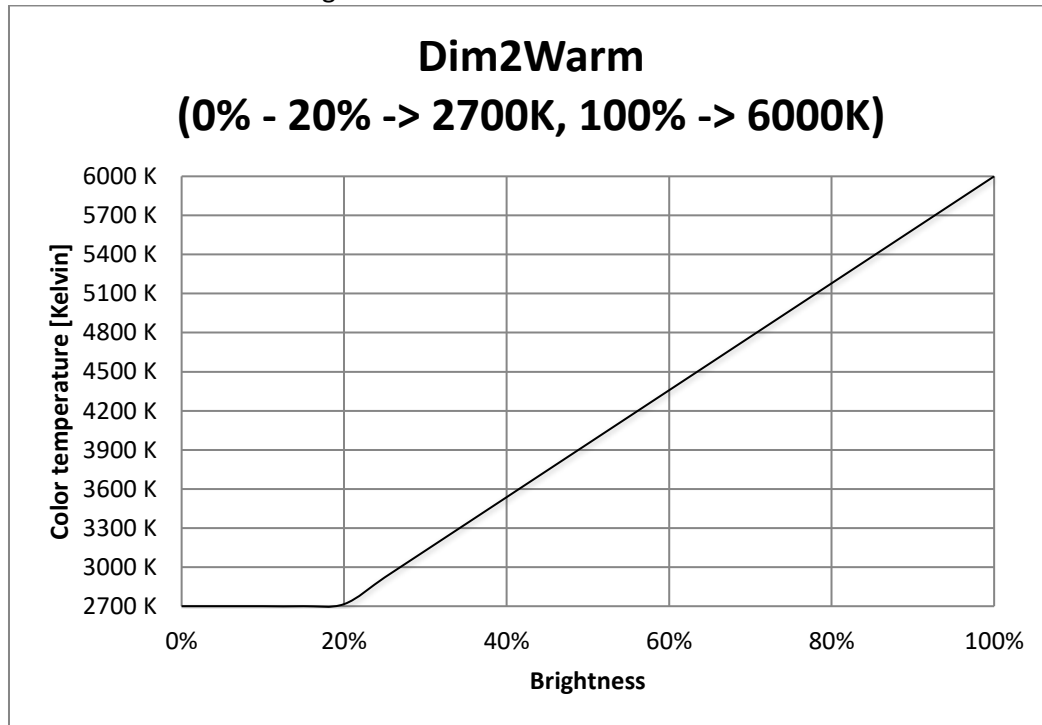

The Dim2Warm function shifts the color temperature in this example from 2700K at 20% brightness to 6000K at 100% brightness. Below 20% brightness the colour temperature remains constant at 2700 Kelvin.

5.3.8.3 Human Centric Light (HCL)

Human Centric Light describes a time-controlled sequence that dynamically adapts the light color to the course of the day.

Activation takes place in the menu "LED RGBW settings", as follows:

Human Centric Light (HCL) not active active

Figure 58: Setting – Activation Human Centric Light (HCL) via RGBW

When Human Centric Light is activated, a submenu for setting the HCL appears:

Switching times time sunrise / sunset

Control brightness over HCL not active active

Action at brightness change via relative dimming HCL is stopped HCL is dimmed

Time 1 06:00 ▼

Color temperature 0% CW, 100% WW (warm +++) ▼

Brightness 50% ▼

Time 2 08:00 ▼

Color temperature 45% CW, 55% WW (neutral) ▼

Brightness 100% ▼

Figure 59: Settings – Human Centric Light (HCL) via RGBW

The following settings are available for the Human Centric Light:

ETS-Text	Dynamic range [Default value]	Comment
Switching times	<ul style="list-style-type: none"> ▪ Time ▪ Sunrise / Sunset 	Setting whether to dim according to fixed times or sunrise/sunset times
Control brightness over HCL	<ul style="list-style-type: none"> ▪ not active ▪ active 	Setting whether fixed brightness values should also be specified for the calibration points
Action at brightness change via relative dimming	<ul style="list-style-type: none"> ▪ HCL is stopped ▪ HCL is dimmed 	Setting whether the brightness of the HCL can be changed via relative dimming commands or whether relative dimming commands terminate the HCL
Fallback time of brightness	<ul style="list-style-type: none"> ▪ no fallback ▪ 1 min – 12 h ▪ daily change (at 00:00) 	Setting the fallback time if the HCL was relatively dimmed. Only available if relative dimming was enabled for HCL
Behaviour at control object „On“	<ul style="list-style-type: none"> ▪ restore brightness change ▪ reset brightness change 	Setting whether relative dimming is reset when switched back on. Only available if relative dimming has been enabled for HCL
Fallback of brightness at repeated „On“	<ul style="list-style-type: none"> ▪ not active ▪ active 	Setting whether relative dimming is reset on repeated "send on". Only available if relative dimming is enabled for HCL
Behaviour at control object „Off“	<ul style="list-style-type: none"> ▪ stop sequence ▪ deactivation 	Setting whether Tunable White is switched off with the control object or only the sequence is stopped
Time 1-10	fixed time from 0-23 o'clock or time depending on sunrise/sunset	Setting the time for the respective base point. Depending on the "Switching times" parameter, fixed times or times depending on sunrise/sunset can be set here
Color temperature	<ul style="list-style-type: none"> • 0% CW, 100% WW • 5% CW, 95% WW • ... • 95% CW, 5% WW ▪ 100% CW, 0% WW 	Adjustment of the color temperature to be controlled for the respective base point
Brightness 1-10	0 – 100%	Adjustment of the brightness to be controlled for the respective base point

Table 59: Settings – Human Centric Light (HCL) via RGBW

The Human Centric Light allows the colour temperature to be adjusted over the course of a day. Depending on the time of day, the channel adjusts the colour temperature and, if set, the brightness for this LED. The Human Centric Light can either be based on sunrise and sunset times (which the dimming actuator calculates itself) or on fixed times. For this purpose, 10 interpolation points (time + brightness value to be controlled) can be defined. The set colour temperature (and brightness) is then reached at the set time. The LED controller interpolates between the calibration points, i.e. if, for example, a colour temperature of 3000K is set for 8:00am and a colour temperature of 3500K for 10:00am, the channel will slowly dim the colour temperature from 3000K to 3500K within these 2 hours.

If the brightness is not controlled via HCL, it is possible, for example, to control the HCL via constant light control.

If the Human Centric Light is to be set to fixed brightness values, it is also possible to dim down the HCL using relative dimming commands (setting: "**Action on brightness change via relative dimming - HCL is dimmed**"). It can only be dimmed down, but not above the set values. With relative dimming, the brightness values of the calibration points are then adjusted according to the dimming command: If, for example, dimming is reduced by 50%, all brightness values are reduced by 50% (30%->15%, 50%->25%, etc.). For relative dimming, there are several ways to reset the brightness change:

- **Fallback time of brightness**
The brightness is automatically reset to the parameter value after a set time.
- **Behaviour at control object „On“**
The brightness is reset to the parameter value when an On command is sent to the control object (start sequence).
- **Fallback of brightness at repeated „On“**
The brightness is reset to the parameter value when two On commands are sent one after the other to the control object (start sequence).

If the parameter value is to be used for dimming upwards, the parameter "Keep HCL/sequences active" has to be set to active. Now the channel can be dimmed upwards at any time and remains there until the next interpolation point is reached. From this point on, the channel synchronizes again with time-dependent dimming until the next interpolation point is reached.

If the parameter "**Control brightness via HCL**" is set to inactive, HCL only controls the colour temperature and not the brightness. In this case, the brightness is kept constant at the start value and can be changed using relative dimming commands or absolute dimming commands.

The parameter "**Behavior at control object "Off"**" can ultimately be used to define whether Tunable White is switched off with the control object or only the sequence is stopped.

The following table shows the associated communication objects:

Number	Name	Length	Usage
131	LED TW Human Centric Light (HCL) – Start HCL	1 Bit	Activating/deactivating the HCL
132	LED TW Human Centric Light (HCL) – HCL State	1 Bit	Output of the status whether HCL is active or not

Table 60: Communication objects – Human Centric Light (HCL) via RGBW

6 Function selection – Dimming Tunable White

If the LED controller is to be operated with Tunable White LEDs, the following selection has to be made in the "Global settings" menu:

The screenshot shows a settings interface with three rows. The first row is 'Function selection' with a dropdown menu showing 'dimming Tunable White'. The second row is 'Setting channels' with a dropdown menu showing '2x Tunable White'. The third row is 'Limit outputs A+B or C+D to 100% (from R5.0)' with two radio buttons: 'not active' (which is selected) and 'active'.

Figure 60: Settings – Function selection Tunable White

Via the parameter "**Setting channels**" you can select whether 2 single Tunable White LEDs (with 4-fold variants) or two channel pairs should drive one Tunable White LED with higher power (setting 1 Tunable White parallel). The parallel connection of 2 channels doubles the permissible total current per LED.

If the channels are connected in parallel, only one Tunable White can be parameterized. The control for the second Tunable White channel is then equal to the first Tunable White channel. Nevertheless, it is absolutely necessary to bridge the channels at the terminals with as short connecting cables as possible.

Please refer to the data sheet for parallel connection!

In addition, if only 1 Tunable White LED is connected, it is possible to use the other channels (with the 3-fold and 4-fold variants) as single channels.

Accordingly, only 1x Tunable White is possible with the 2-fold variant.

Limit outputs A+B or C+D to 100% (from R5.0)

This setting can be used to ensure that channels A and B (or C and D) are never controlled simultaneously in single channel control. This is useful for loads where, for thermal reasons, only one of the two white channels may be controlled at any time. Example: If KW = 100% and WW = 100% is required when the parameter is activated, only 50% and 50% are controlled at the output of the output stage. In this case, the status objects continue to output 100% and are not reduced to 50%. This function requires a hardware version of the LED controller from R5.0.

6.1 Communication objects – Default settings

Default settings – Tunable White								
No.	Name	Function	Length	C	R	W	T	U
0/ 16/ 32/ 48	Channel A/B/C/D (TW 1/2 – Cold White/ Warm White)	Swith On/Off	1 Bit	X		X		
2/ 18/ 34/ 50	Channel A/B/C/D (TW 1/2 – Cold White/ Warm White)	Dimming relative	4 Bit	X		X		
3/ 19/ 35/ 51	Channel A/B/C/D (TW 1/2 – Cold White/ Warm White)	Dimming absolute	1 Byte	X		X		
4/ 20/ 36/ 52	Channel A/B/C/D (TW 1/2 – Cold White/ Warm White)	State On/Off	1 Bit	X	X		X	
5/ 21/ 37/ 53	Channel A/B/C/D (TW 1/2 – Cold White/ Warm White)	State of dimming value	1 Byte	X	X		X	
64	LED TW	Switch On/Off	1 Bit	X		X		
65	LED TW1	Staircase light	1 Bit	X		X		
74	LED TW 1 color temperature (Level CW in %)	Dim absolutely	1 Byte	X		X		
75	LED TW 1 color temperature (Kelvin)	Dim absolutely	2 Byte	X		X		
76	LED TW 1 Brightness	Dim absolutely	1 Byte	X		X		
77	LED TW1 Transition (color temperature and Brightness)	Dim absolutely	6 Byte	X		X		
78	LED TW 1 color temperature (Level CW in %)	Dim relatively	4 Bit	X		X		
79	LED TW 1 Brightness	Dim relatively	4 Bit	X		X		
80	LED TW1	State On/Off	1 Bit	X	X		X	
86	LED TW 1 color temperature (Level CW in %)	State of dimming value	1 Byte	X	X		X	
87	LED TW 1 color temperature (Kelvin)	State of dimming value	1 Byte	X	X		X	
88	LED TW 1 Brightness	State of dimming value	1 Byte	X	X		X	
89	LED TW1	Scene	1 Byte	X		X		
90	LED TW1	Start Bit Scene 1	1 Bit	X		X		
91	LED TW1	Start Bit Scene 2	1 Bit	X		X		
92	LED TW1	Start Bit Scene 3	1 Bit	X		X		
93	LED TW1	Start Bit Scene 4	1 Bit	X		X		
94	LED TW1	Block 1	1 Bit	X		X		
95	LED TW1	Block 2	1 Bit	X		X		
96	LED TW1	Block state	1 Bit	X		X		
+26	next Tunable White Channel							

119	LED TW1	Start Sequence 1	1 Bit	X		X		
120	LED TW1	Sequence 1 state	1 Bit	X	X		X	
121	LED TW1	Start Sequence 2	1 Bit	X		X		
122	LED TW1	Sequence 2 state	1 Bit	X	X		X	
123	LED TW1 Human Centric Light (HCL)	Start HCL	1 Bit	X		X		
124	LED TW1 Human Centric Light (HCL)	HCL State	1 Bit	X	X		X	
+8	Sequences for the next Tunable White Channel							

Table 61: Standard settings and communication objects – Tunable White

The default settings can be found in the table above. The priority of the individual communication objects and the flags can be adjusted by the user as required. The flags assign the respective programming tasks to the communication objects, where C stands for Communication, R for Read, W for Write, T for Transfer and U for Update.

6.2 Reference ETS-Parameter

6.2.1 Global Settings

The following parameters are available in the "Global settings" menu:

Relais request via object (from R5.0)	not active
Use relais as	<input type="radio"/> switch channel <input checked="" type="radio"/> switching off if all channels = 0%
Off delay of relais	5 s
Switching off delay time of relais in sequence	5 s
Behavior at bus power down	no change
<hr/>	
Brightness of activation during manual operation	100%
PWM frequency	<input checked="" type="radio"/> 600 Hz <input type="radio"/> 1 kHz
Dimming curve	quadratic
Reduction of brightness Channel A	0% (full output power)
Reduction of brightness Channel B	0% (full output power)
Reduction of brightness Channel C	0% (full output power)
Reduction of brightness Channel D	0% (full output power)
Hold HCL/Sequence active	<input type="radio"/> not active <input checked="" type="radio"/> active
Note: HCL, Sequences, Time dependent dimming will be stopped only by switching off.	

Figure 61: Global Settings – Tunable White

The table shows the setting options for the general settings (Settings for relay or relay request see "4.2.1 Global settings, individual channels):

ETS-Text	Dynamic range [Default value]	Comment
Switch-on brightness for manual operation	0% - 100% [100%]	Adjustment of the switch-on brightness when the device is controlled via the handset. Only available for MDRC version!
PWM frequency	<ul style="list-style-type: none"> • 600Hz • 1kHz 	Setting the PWM frequency
Dimming curve	<ul style="list-style-type: none"> • quadratic • logarithmic • semi-logarithmic • linear 	Setting the dimming behaviour. It is recommended to use the square dimming curve
Reduction of brightness Channel A-D	0-50% [0% (full output power)]	Reducing the maximum output power for the channel
Hold HCL/Sequence active	<ul style="list-style-type: none"> • not active • active 	This parameter determines whether HCL, time-dependent dimming and sequences can be stopped by other actions

Table 62: Global Settings – Tunable White

Reduction of brightness Channel A-D:

The limitation of the output power serves to scale the brightness for a channel down by the given percentage, e.g. if a light band is clearly too bright. All status values, dimming values still refer to 100% after scaling, but the brightness is reduced by the specified percentage.

Hold HCL/Sequence active:

With this parameter, a sequence is not stopped by On/Off, relative dimming, absolute dimming, etc. The action is performed and the end value is held until the current waiting time/dimming time has elapsed. It is only possible to stop the current sequence with the following actions:

- Stopping the sequence/HCL via the respective sequence object
- Starting another sequence/HCL
- Switch-on action via switching On/Off
- Switch-off action via switching On/Off
- Blocking
- Unblocking

The relay can be used both to switch off the power supply when all channels are off - to avoid standby consumption - and as a separate switching channel. If the relay is used as a separate switching channel, a new communication object appears for control. The following table shows the corresponding communication object:

Number	Name	Length	Usage
141	Relais Switch On/Off	1 Bit	Switching the relay if it has been selected as the switching channel
142	Relais State	1 Bit	Output to indicate current state

Table 63: Communication objects – Relais as Switch channel

The relay request (from R5.0) can be configured as master or slave. The objects then change for the relay. The LED controller without relay contact can only be configured as slave. Due to the possibility Master / Slave several controllers can work with one voltage source which the Master switches with its relay.

Number	Name	Length	Usage
141	Relay request	1 Bit	Input for relay request
142	Relay state	1 Bit	State output

Table 64: Communication objects – Relay request Master

Number	Name	Length	Usage
142	Relay request output	1 Bit	Output for relay request

Table 65: Communication objects – Relay request Slave

6.2.2 Tunable White – Control

The following communication objects are available for controlling the Tunable White LEDs:

Number	Name	Length	Usage
74	LED TW Color temperature (level of CW in %)	1 Byte	Specification of a new absolute proportion of cold white
75	LED TW Color temperature (Kelvin)	2 Byte	Specification of a new colour temperature in Kelvin
76	LED TW Brightness	1 Byte	Specification of a new absolute value for the brightness of Tunable White
77	LED TW transition (color temperature and brightness)	6 Byte	Control of brightness and color temperature
78	LED TW Color temperature (level in %)	4 Bit	Relative dimming of the cold white component
79	LED TW Brightness	4 Bit	Relative dimming of brightness

Table 66: Communication objects – Tunable White Control

Object 74 can be used to set a new color temperature for the Tunable White LED. This is transferred as a proportion KW in %. The LED controller then converts the warm white component into the corresponding equivalent. Via **object 75**, a new absolute colour temperature in Kelvin can be set for the LED controller. The new colour temperature must be higher than the colour temperature set in the parameters for warm white and lower than the colour temperature set in the parameters for cold white.

Object 76 gives the channel an absolute brightness.

The 6 byte **object 77** contains information about both the absolute brightness and the absolute color temperature. This object is defined in the KNX specification with the DPT 249.600:

DPT Name	DPT_Brightness_Colour_Temperature_Transition		
DPT_Format	U ₁₆ U ₁₆ U ₈ B ₈		
Field	Description	Range	Unit
Time period	Unsigned time value for calculating the transition period	0 – 6553,5s	100m sec
Absolute color temperature	Color temperature of the lamp	0 – 65535K	K
Absolute Brightness	Absolute brightness of the Lamp	0-100%	%
Masking B2	Validity of the time period	0, 1	-
Masking B1	Validity of the absolute color temperature	0, 1	-

Table 67: KNX Specification – DPT 249.600

Object 78 can be used to dim the color temperature relatively. A decrease shifts the Tunable White LEDs to warm colors and an increase to cold colors.

Object 79 can be used to dim the brightness relatively.

6.2.3 Tunable White

6.2.3.1 Switch On-/ Off behaviour

The following figure shows the available settings for the switch-on behavior:

Delays:	
Switching on delay	no delay ▼ s
Switching off delay	no delay ▼ s
Switching on behavior at day	fixed CW- and WW-values ▼
Activation value Cold White at day	100% ▼
Activation value Warm White at day	100% ▼
Switching on speed at day	2 ▲▼ s
Switching off speed at day	2 ▲▼ s

Figure 62: Settings – Switch On behaviour Tunable White

The switch-on behaviour can be set separately for day and night. Both the respective switch-on behaviour and the specific switch-on/switch-off speeds can be defined.

The following switch-on behaviour can be parameterised:

- **Last value value/sequence**
The value before switching off is restored or the sequence which was active before switching off is started
- **fixed CW and WW values**
Fixed values are dimmed for cold white and warm white
- **fixed TW values**
Fixed values for color temperature and brightness are dimmed
- **Start sequenz 1 / 2**
Sequence 1 / 2 is startet
- **Start HCL**
HCL is startet

The set times have the following effects:

- **Switch on delay**
The switch-on delay defines the time between the switch-on pulse and the first dimming of the respective channel.
- **Switch off delay**
The switch-off delay defines the time between the switch-off pulse and the first dimming of the respective channel.

- Switch on speed**
 A soft-start function is realized by the switch-on speed. The switch-on time refers only to the "hard" switch-on, e.g. after a reset or via the object "LED TW 1/2 switching" and not to the dimming up of 0%. With a switch-on time of 2s, the TW LED is slowly dimmed to the set value within 2s.
- Switch off speed**
 A soft-stop function is realized by the switch-off speed. The switch-off time refers only to the "hard" switch-off, e.g. via the object "LED TW 1/2 switching" and not to the dimming down to 0%. With a switch-off time of 2s, the Tunable White LED is dimmed to 0% within 2s.

6.2.3.2 Staircase light

The following figure shows the available settings for the staircase lighting function:

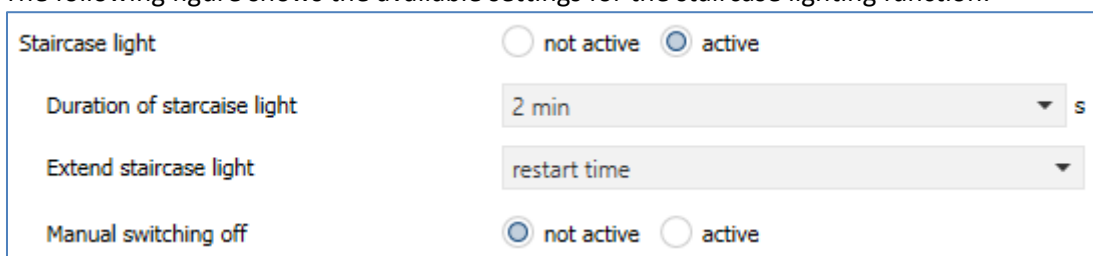

Figure 63: Settings – Staircase light

The following table shows the setting options for the staircase lighting function, when activated:

ETS-Text	Dynamic range [Default value]	Comment
Duration of staircase light	No delay, 1s,5s,10s,15s,20s,30s,45s,60s 2/3/4/5/6/7/8/9/10/15/20/30/ 45/60/90/120/180/240min	Duration of the staircase time. Sets the time of how long light is switch-on
Extend staircase light	<ul style="list-style-type: none"> not active restart time add up time 	Allows a possible extension of the staircase light time
Manual switching off	<ul style="list-style-type: none"> not active active 	Allows to switch-off manually before the staircase lighting time has elapsed

Table 68: Settings – Staircase light

The staircase lighting function switches on the Tunable White LED with the settings for the day/night switch-on behaviour for the set staircase lighting duration.

The "**Extend staircase light**" parameter can be used to activate that a new ON telegram either restarts the staircase lighting time from 0s or extends the currently running staircase lighting time by the staircase lighting duration. With the latter setting, the staircase timer can be extended as required.

The "**Manual switch-off**" parameter can be used to define whether an OFF telegram causes the channel to be switched off or whether an OFF telegram is ignored and the channel is only switched off after the staircase timer has elapsed.

If the staircase lighting function is activated, a new "Staircase lighting" communication object appears in addition to the Switching object.

Number	Name	Length	Usage
65	Staircase light	1 Bit	activates the staircase lighting function

Table 69: Communication object – Staircase light

6.2.3.3 Dimming speed

Several dimming speeds can be set to set transitions and Soft-Start/Stop:

Dimming speeds:

Relative dimming Brightness (V)	10	▲ ▼ s
Relative dimming Color temperature	10	▲ ▼ s
Absolute dimming	1	▲ ▼ s

Figure 64: Settings – Dimming speed

The individual parameters have the following effects:

- **Relative dimming Brightness (V)**
This defines the time for the relative dimming of the brightness.
- **Relative dimming color temperature**
This defines the time for the relative dimming of the color temperature.

The times for relative dimming refer to a relative dimming process of 100%. If a time of 10s were entered, the relative dimming would take 10s from 0 to 100% and vice versa. Relative dimming by 50% would take 5s.

- **Dimming speeds for absolute dimming**
Defines the time for all absolute dimming processes related to an absolute dimming process of 100%. If a time of 10s were entered, absolute dimming would take from 0 to 100% and vice versa 10s. Absolute dimming by 50% would take 5.

6.2.3.4 Switch-on color temperature with relative dimming

The following figure shows the setting options for the switch-on behaviour:

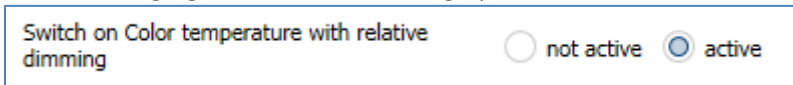

Figure 65: Settings – Switch-on with relative dimming

The parameter has the following effects:

With relative dimming of the colour temperature, the channel is switched on. If this parameter is not active, relative dimming of the colour temperature would have no effect when switched off.

6.2.3.5 Status output

The following screen shows the available settings for the status output:

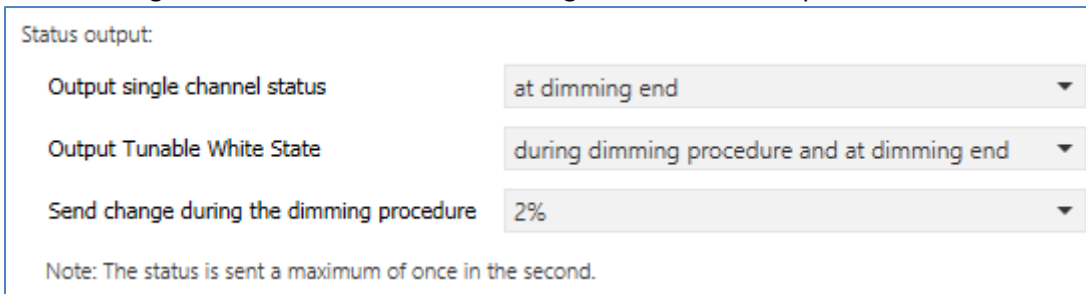

Figure 66: Settings – Status output

A status for each of the two individual channels as well as a state for the entire Tunable White LED can be output. The status can either be output at the end of dimming, i.e. when a dimming process has been completed, or during dimming and at the end of dimming. If the status is to be output during the dimming process, a change rate can be output at which the status is sent. However, a maximum of one status per second is output

The following table shows the corresponding communication objects:

Number	Name	Length	Usage
5 / 37	Channel A/C (TW 1/2 – Cold White)	1 Byte	State output of the Cold White proportion
21 / 53	Channel B/D (TW 1/2 – Warm White)	1 Byte	State output of the Warm White proportion
86 / 107	LED TW 1/2 Color temperature (Level CW in %)	1 Byte	Output of colour temperature in % and how much Cold White part is active
87 / 108	LED TW 1/2 Color temperature (Kelvin)	2 Byte	Output of colour temperature in Kelvin
88 / 109	LED TW 1/2 Brightness	1 Byte	Output of the current brightness

Table 70: Communication objects – Tunable White_Status Output

6.2.3.6 Behaviour after Reset

The following figure shows the possible settings for the behaviour after a reset:

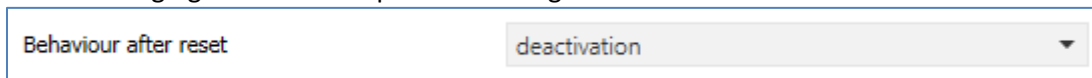

Figure 67: Setting – Behaviour after Reset

The following settings are available:

- **Deactivation**
The channel is switched off after a reset.
- **Activation value Day/Night**
The switch-on value for day or night is called up.
- **Last value/sequence**
The value before the reset is restored or the sequence which was active before the reset is started.
- **Fixed CW and WW values**
Fixed Cold White and Warm White values are dimmed.
- **Fixed TW values**
Fixed values for color temperature and brightness are dimmed.
- **Start sequence 1/2**
It is started with sequence 1 or 2.
- **Start HCL**
HCL is started.

6.2.4 Tunable White Settings

6.2.4.1 Basic Settings

The following picture shows the basic settings for Tunable White in the menu LED TW 1/2 Setting:

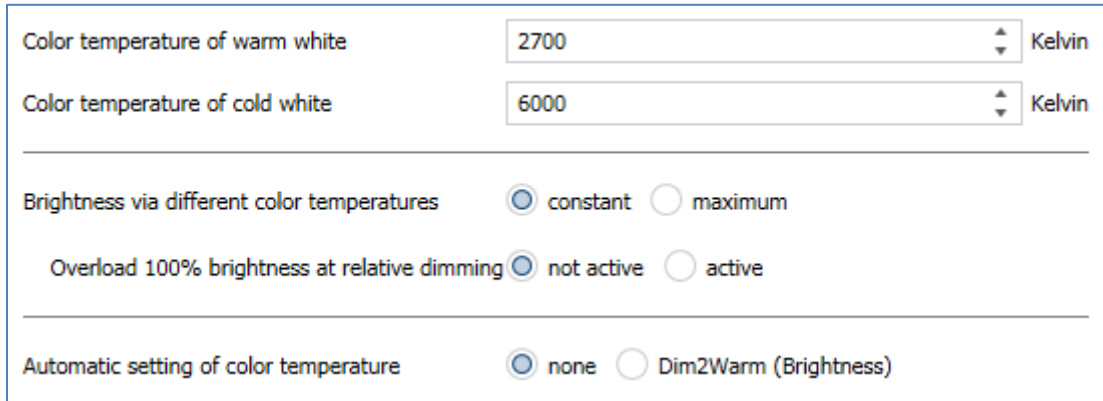

The screenshot shows a settings menu with the following options:

- Color temperature of warm white: 2700 Kelvin
- Color temperature of cold white: 6000 Kelvin
- Brightness via different color temperatures: constant maximum
- Overload 100% brightness at relative dimming: not active active
- Automatic setting of color temperature: none Dim2Warm (Brightness)

Figure 68: Basic Settings – Tunable White

The following basic settings are available:

ETS-Text	Dynamic range [Default value]	Comment
Color temperature of Warm White	2000 ... 3300 Kelvin [2700 K]	Setting the colour temperature for Warm White
Color temperature of Cold White	4000 ... 8000 Kelvin [6000 K]	Setting the colour temperature for Cold White
Brightness via different color temperatures	<ul style="list-style-type: none"> • constant • maximum 	Setting the calculation of the brightness for "100%"
100% Brightness override with relative dimming	<ul style="list-style-type: none"> • not active • active 	Setting whether the brightness can be overridden after reaching 100%

Table 71: Basic Settings – Tunable White

The setting “**Colour temperature of Warm White/Cold White**” is used to set the dimming range of the colour temperature. For example, if the colour temperature of Warm White is set to 2700K and the colour temperature of Cold White to 6000K, the colour temperature can be changed from 2700K to 6000K.

The parameter “**Brightness via different colour temperatures**” defines the behaviour of brightness when the colour temperature is changed. The following settings are available:

- **constant**

If the colour temperature is changed, the brightness at the output remains constant. The following diagram shows the control of Warm White and Cold White at a set brightness level:

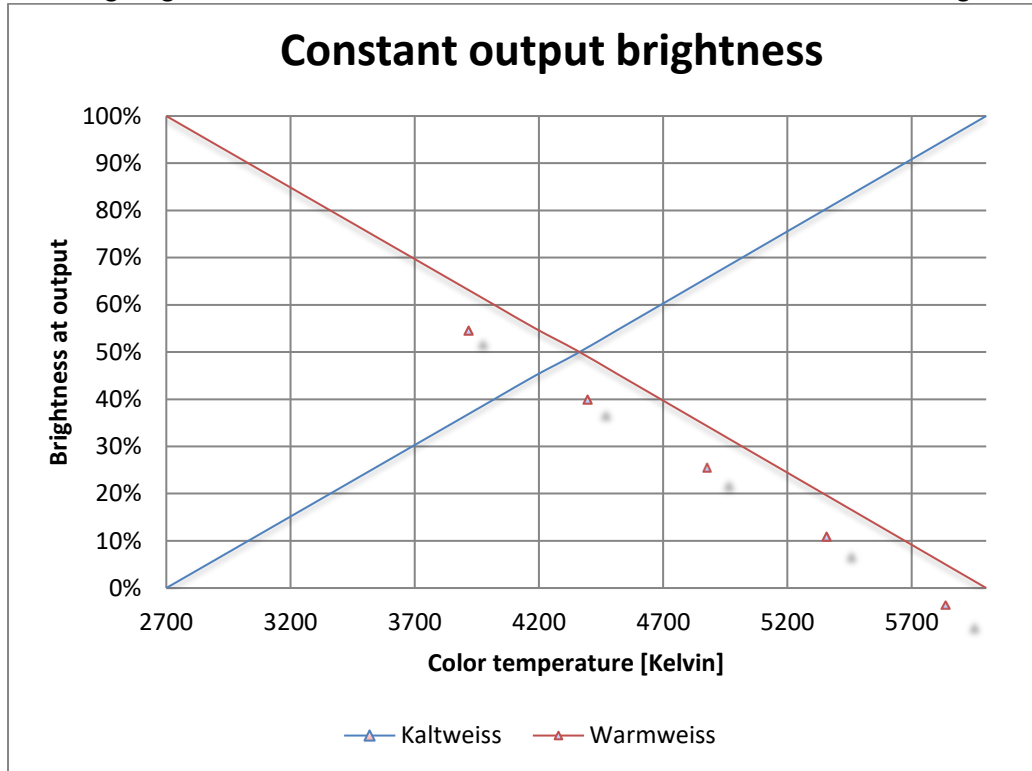

If the colour temperature is set to Warm White (2700K), Warm White has 100% output power. If the colour temperature is now shifted to Cold White, the output power of Warm White decreases and the output power of Cold White increases accordingly. The total output power remains constant over the entire range of the colour temperature change. This means that different values are approached with different dimming curves. For example, with a 50% Cold White component in the square dimming curve, the value 70% is approached, as this corresponds to a brightness of 50% at the output.

The parameter “**Override 100% brightness with relative dimming**” can be used to override the constant brightness upwards. For example, the colour temperature could be dimmed upwards with 50% Cold White and the value for Cold White and Warm White could be increased from 70% to up to 100%.

- **maximum**

The maximum setting sets the values for Warm White and Cold White to the maximum possible value. The following diagram shows the output power of Warm White and Cold White at a set brightness level:

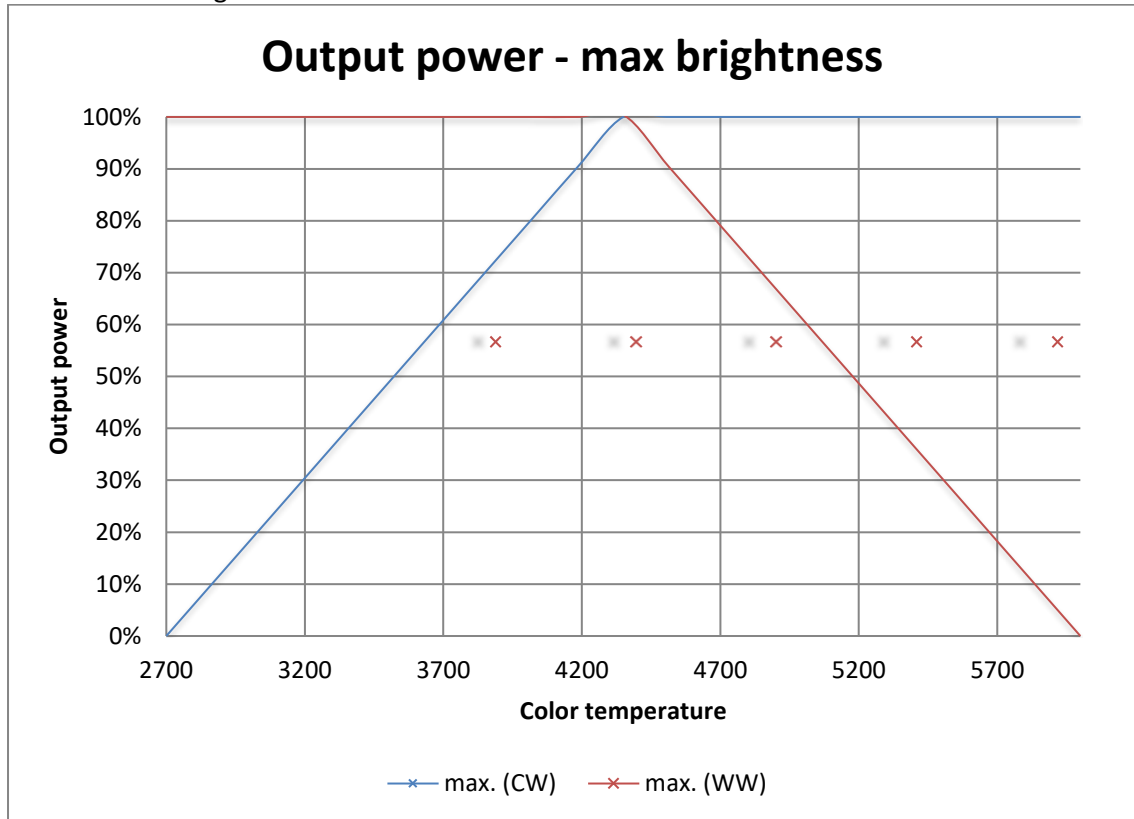

If the colour temperature is set to Warm White (2700K), Warm White has 100% output power and Cold White 0% output power. If the colour temperature is now shifted to cold white, the output power of Cold White increases without the output power of Warm White being reduced.

6.2.4.2 Dim2Warm

If Dim2Warm is activated, it is no longer possible to adjust the colour temperature manually, as this happens dynamically due to the change in brightness! The communication objects are hidden. The Dim2Warm function automatically adjusts the colour temperature when the brightness changes. The following figure shows the available settings:

Automatic setting of color temperature none Dim2Warm (Brightness)

Control of Color temperature is valid active for all dimming procedure ▼

Note: Preset color temperatures will be ignored when the coupling is activated.

Color temperature, if lower than brightness threshold 1 (dark) 0% CW, 100% WW (warm +++) ▼

Brightness threshold 1 (dark) 0% ▼

Color temperature, if upper than brightness threshold 2 (bright) 100% CW, 0% WW (cold +++) ▼

Brightness threshold 2 (bright) 100% ▼

Figure 69: Settings – Dim2Warm (Brightness)

The Dim2Warm function automatically shifts the colour temperature to a warm colour temperature when the brightness is reduced. The following diagram shows the adjustment of the colour temperature for a warm colour temperature of 2700K and a cold colour temperature of 6000K and a Dim2Warm function activated with default settings (see Figure 52: Dim2Warm):

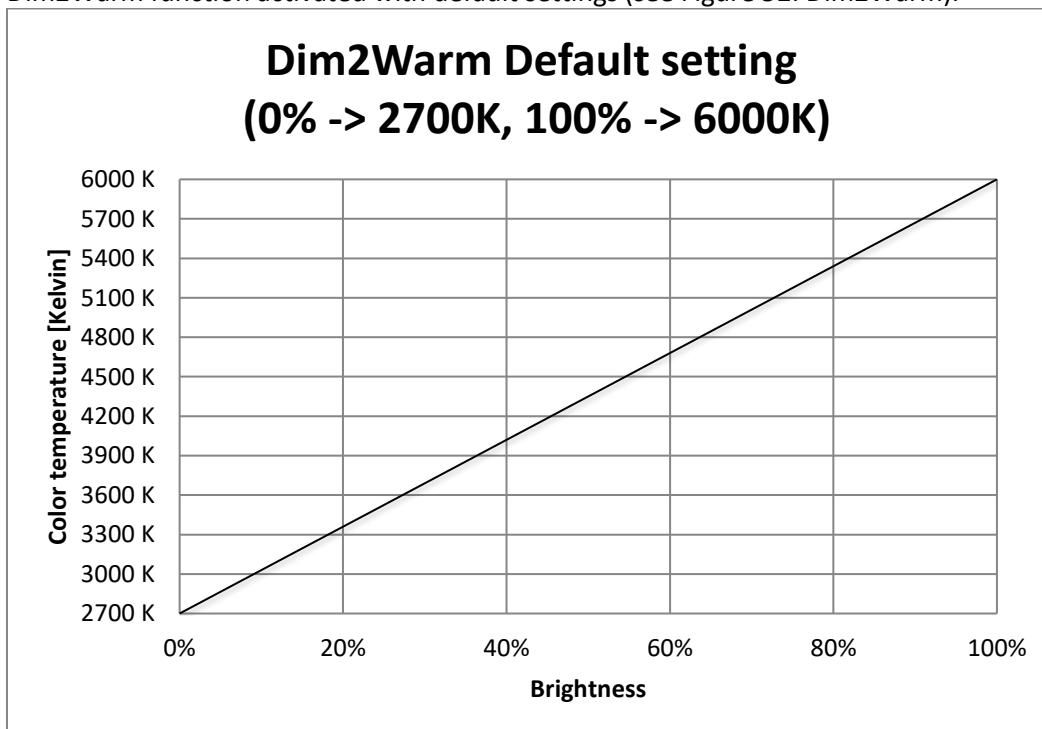

The Dim2Warm function shifts the color temperature in this example from 2700K at 0% brightness to 6000K at 100% brightness.

The following parameter settings are available for the Dim2Warm function:

ETS-Text	Dynamic range [Default value]	Comment
Automatic setting of color temperature	<ul style="list-style-type: none"> ▪ none ▪ Dim2Warm (Brightness) 	Activation of the „Dim2Warm“ function
With activation of “Dim2Warm” the following parameters appear:		
Control of Color temperature is valid	<ul style="list-style-type: none"> • active for all dimming procedures • active for relative- and absolute dimming procedures • active for switching On/Off of dimming procedures • active for switching on/off, relative and absolute dimming procedures 	Setting for which dimming processes Dim2Warm is active
Color temperature, if lower than brightness threshold 1 (dark)	<ul style="list-style-type: none"> • 0% CW, 100% WW • 5% CW, 95% WW • ... • 95% CW, 5% WW • 100% CW, 0% WW 	Setting which colour temperature is to be set below brightness threshold 1 during dimming
Brightness threshold 1 (dark)	0 – 45 % [0 %]	Setting from when the shift to warm color temperature takes effect
Color temperature when higher than Brightness threshold 2 (bright)	<ul style="list-style-type: none"> • 0% CW, 100% WW • 5% CW, 95% WW • ... • 95% CW, 5% WW • 100% CW, 0% WW 	Setting which colour temperature is to be set when dimming via the brightness threshold 2
Brightness threshold 1 (bright)	50 – 100 % [100 %]	Setting from when the shift to the cold colour temperature is active

Table 72: Settings – Dim2Warm

The parameter "Control of colour temperature valid" defines for which dimming processes the Dim2Warm function is to apply. The settings have the following effect:

- **active for all dimming procedures**
Dim 2 Warm is active for all dimming processes except sequences. This means that Dim2Warm is also executed when scenes, bit scenes or disable/force functions are called up.
- **active for relative- and absolute dimming procedures**
Dim2Warm is only active for dimming processes via the objects LED TW Brightness - Dimming Absolute and LED TW Brightness - Dimming Relative (objects 76 and 79).
- **active for switching On/Off of dimming procedures**
Dim2Warm is only active for on/off operations via the 1 Bit switching objects (64 and 65).
- **active for switching on/off, relative and absolute dimming procedures**
Dim2Warm is active for dimming processes via the objects LED TW Brightness - Dimming Absolute and LED TW Brightness - Dimming Relative and for switch-on/switch-off processes via the 1 Bit Switching object (objects 64, 65, 76 and 79). However, it is not for calling scenes/bit scenes or disable/force functions or sequences.

If the Dim2Warm function is parameterised with the following settings:

Automatic setting of color temperature	<input type="radio"/> none <input checked="" type="radio"/> Dim2Warm (Brightness)
Control of Color temperature is valid	active for all dimming procedure ▼
Note: Preset color temperatures will be ignored when the coupling is activated.	
Color temperature, if lower than brightness threshold 1 (dark)	0% CW, 100% WW (warm +++) ▼
Brightness threshold 1 (dark)	20% ▼
Color temperature, if upper than brightness threshold 2 (bright)	100% CW, 0% WW (cold +++) ▼
Brightness threshold 2 (bright)	100% ▼

Figure 70: Settings – Dim2Warm, Example 20%

This results in the following behavior:

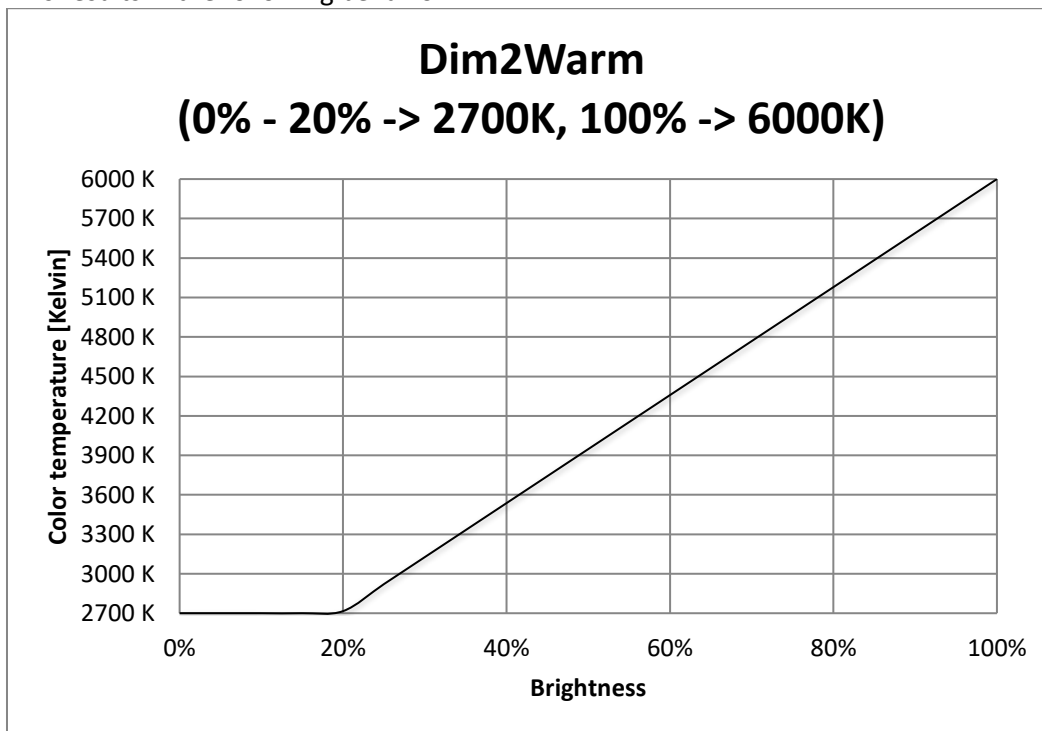

The Dim2Warm function shifts the color temperature in this example from 2700K at 20% brightness to 6000K at 100% brightness. Below 20% brightness the colour temperature remains constant at 2700 Kelvin.

6.2.5 Block and Force Functions

The blocking function blocks the Tunable White LED for further operation and can call up additional defined states. The following figure shows the parameters for the disable process:

Block object 1 - datapoint type	18bit Object
Action at object value = 1	<input checked="" type="radio"/> block <input type="radio"/> unblock/enable
Action at object value = 0	unblock/enable
Action at locking	fixed CW- and WW-values
Value Cold White	0%
Value Warm White	100%
<hr/>	
Action at unlocking	hold value / no change
Dimming speed	2 s
Release time (0s=not active)	0 s
<hr/>	
Block object 2 - datapoint type	not active

Figure 71: Settings – Block and Force functions (Tunable White)

Each channel has 2 independent blocking functions, whereby blocking function 1 has a higher priority than blocking function 2.

Each block function can be activated/ deactivated by a 1-Bit object, a 2 Bit object or a 1 Byte object.

The following table shows the available setting options for the various blocks:

ETS-Text	Dynamic range [Default value]	Comment
Block object 1/2 – Data point type	<ul style="list-style-type: none"> • not active • 1 Bit Objekt • 2 Bit Object • 1 Byte dimming value 	Selection of whether the blocking object is active and, if so, with which datapoint type it is to be executed
Selection: via 1 Bit object		
Block object 1/2 – Data point type	<ul style="list-style-type: none"> • 1 Bit Object 	Selection of the data point type for the lock object
Action at object value = 1	<ul style="list-style-type: none"> • block • unblock/enable 	Setting whether value 1 is to be locked or unlocked
Action at object value = 0	is determined automatically after selection of the action with object value = 1	Setting whether to lock or unlock at value 0; is automatically defined by action at value = 1
Selection: via 2 Bit object		
Block object 1/2 – Data point type	<ul style="list-style-type: none"> • 2 Bit Object 	Selection of the data point type for the lock object
Action at object value Force ON	block	With object value Force ON, the channel is always blocked. Not adjustable
Action at object value Force OFF	<ul style="list-style-type: none"> • Block -> Off • No change 	Setting of the action to be performed in case of force OFF
Action at object value Force End	unlock/enable	With object value Force end, the channel is always unlocked. Not adjustable
Selection: via 1 Byte object		
Block object 1/2 – Data point type	<ul style="list-style-type: none"> • 1 Byte Object 	Selection of the data point type for the lock object
Action at dimming value = 0%	unlock/enable	With object value 0%, the channel is always unlocked. Not adjustable

Block object 1/2 -> Action at locking/ unlocking	<ul style="list-style-type: none"> • Deactivation • Activation value (Day/Night) • Hold value/no change • Value before locking • fixed CW and WW values • fixed TW values • TW – change Hue • TW – change Brightness • Start Sequence 1-2 • Start HCL • Stop Sequence 	Setting the action at locking / unlocking
Dimming speed	0 ... 120 s [2s]	Setting the dimming speed for calling up a brightness value
Release time (0 = not active)	0 ... 32000 s [0s]	Setting whether the disable function is automatically reset after a defined time.

Table 73: Settings – Block and Force Functions (Tunable White)

Disable functions 1 and 2 can be triggered with 3 different data point types. The behavior is then as follows:

- **1 Bit Object**
It can be freely defined whether the channel with the "0" or the "1" is to be locked/unlocked. The actions for locking/unlocking can also be set.
- **2 Bit Object**
By means of 2 bit forced control, the channel is blocked with object value Force ON (11). The channel is unlocked with object value Forced end (00). The action for Forced Off (10) can be set to "Block -> Off" or "No change".
- **1 Byte Objekt**
The channel is set to the corresponding value via a dimming value >0% by means of 1 byte object (it can be specified whether the colour temperature, saturation or brightness is to be changed for HSV and the colour temperature or brightness is to be changed for Tunable White) and disabled. The value 0% unlocks the channel again.

The following actions can be defined for disable/unlock (for the disable function via 1 byte object it can be defined which parameter (TW colour temperature, TW brightness) should be changed if a dimming value >0% is sent) and unlock:

- **Deactivation**
The channel is switched off.
- **Activation value (Day/Night)**
The channel is set to the currently valid switch-on value (depending on whether it is day or night).
- **Hold value / no change**
The channel remains in its current state.
- **Value before locking**
The channel takes on the state before locking.
- **fixed CW and WW values**
Fixed values are dimmed for Cold White and Warm White.
- **fixed TW values**
A freely adjustable Tunable White value is controlled.
- **TW – change color temperature**
Only the color temperature is set to a freely adjustable value. The brightness remains at its current value.
- **TW – change Brightness**
Only the brightness is set to a freely adjustable value. The color temperature remains at its current value.
- **Start sequence 1/2**
The respective sequence is started.
- **Start HCL**
HCL is startet.
- **Stop sequence**
All active sequences are stopped.

The following table shows the corresponding communication objects:

Number	Name	Length	Usage
94 /115	TW 1/2 – Block 1	1 Bit 2 Bit 1 Byte	Block object 1, type depends on the data point settings for the first block object
95 /116	TW 1/2 – Block 2	1 Bit 2 Bit 1 Byte	Block object 2, type depends on the data point settings for the second block object
96 /117	TW 1/2 – Block state	1 Bit	Transmits a 1 if channel is locked and a 0 if channel is not locked

Table 74: Communication objects – Block functions Tunable White

6.2.6 Tunable White Bit-Scenes

The following picture shows the available settings for the bit scenes:

Bit Scene 1	<input type="radio"/> not active <input checked="" type="radio"/> active
Description	<input type="text"/>
Action at value = 1	fixed TW-values ▼
Color temperature Bit value 1	0% CW, 100% WW (warm +++) ▼
Brightness Bit value 1	100% ▼
Action at value = 0	deactivation ▼
Dimming speed	<input type="text" value="0"/> s ▲▼
Bit Scene 2	<input checked="" type="radio"/> not active <input type="radio"/> active
Bit Scene 3	<input checked="" type="radio"/> not active <input type="radio"/> active
Bit Scene 4	<input checked="" type="radio"/> not active <input type="radio"/> active

Figure 72: Settings – Bit Scenes TW

The functionality of the bit scenes is analogous to that of the normal scene function, only that an action can be triggered for both the value 0 and the value 1. The bit scenes can be triggered via simple switching functions.

The following settings are available for an activated bit scene:

ETS-Text	Dynamic range [Default value]	Comment
Description	Freely selectable name	For identification of the bit scene; name is also adopted in the communication objects
Action at value = 1/ value = 0	<ul style="list-style-type: none"> ▪ Deactivation ▪ Activation value (Day/Night) ▪ Hold value/no change ▪ fixed CW/WW values ▪ fixed TW values ▪ TW – change Hue ▪ TW – change Brightness ▪ Start Sequence 1-2 ▪ Start HCL ▪ Stop Sequence ▪ Enable Block 1 ▪ Enable Block 2 ▪ Unlocking 	Setting for the reception of the value 0/1 on the bit scene object
Dimming speed	0 ... 14400 s [0 s]	Setting the dimming speed for calling up scenes

Table 75: Settings – Bit scenes TW

The following actions can be defined for the value 0 and 1 of the bit scenes:

- **Deactivation**
The channel is switched off.
- **Activation value (Day/Night)**
The channel is set to the currently valid switch-on value (depending on whether it is day or night).
- **Hold value / no change**
The channel remains in its current state.
- **fixed CW/WW values**
A freely adjustable Cold White or Warm White value is controlled.
- **fixed TW values**
A freely adjustable Tunable White value is controlled.
- **TW – change color temperature**
Only the color temperature is set to a freely adjustable value. The brightness remains at its current value.
- **TW – change Brightness**
Only the brightness is set to a freely adjustable value. The color temperature remains at its current value.
- **Start sequence 1-2**
The respective sequence is started.
- **Start HCL**
HCL is started.

- **Stop sequence**
All active sequences are stopped.
- **Enable Block 1/2**
Block 1/2 is activated.
- **Unlocking**
The LED controller is unlocked.

The following table shows the corresponding communication objects:

Number	Name	Length	Usage
90	Start Bit Scene 1	1 Bit	Call up of Bit Scene 1
91	Start Bit Scene 2	1 Bit	Call up of Bit Scene 2
92	Start Bit Scene 3	1 Bit	Call up of Bit Scene 3
93	Start Bit Scene 4	1 Bit	Call up of Bit Scene 4

Table 76: Communication objects – Bit Scenes TW

6.2.7 Tunable White Scenes

Up to 8 scenes can be programmed which can be assigned to one of the 64 possible scene numbers. The following picture shows the possible settings in the submenu LED TW 1/2 Scene:

Save scene	not active
Scene number A	7
Action	fixed CW- and WW-values
Value Cold White	0%
Value Warm White	100%
Dimming speed	1 s
Scene number B	not active
Scene number C	not active
Scene number D	not active
Scene number E	not active
Scene number F	not active
Scene number G	not active
Scene number H	not active

Figure 73: Settings – Scenes TW

Die nachfolgende Tabelle zeigt die Einstellmöglichkeiten für eine aktivierte Szenenfunktion:

ETS-Text	Dynamic range [Default value]	Comment
Save scene	<ul style="list-style-type: none"> • not active • active • Keep learned scene (no takeover of parameter) 	Setting whether the current value of the scene can be saved (only for action: brightness value) and whether the value is reset after reprogramming. Save scene active: Saved value is reset after reprogramming. Keep learned scene: Stored value is retained after reprogramming
Scene number A-H	not active 1 – 64	Setting the scene number for scene recall
Action	<ul style="list-style-type: none"> ▪ Deactivation ▪ Activation value (Day/Night) ▪ Fixed CW/WW values ▪ fixed TW values ▪ TW – change Hue ▪ TW – change Brightness ▪ Start Sequence 1-2 ▪ Start HCL ▪ Stop Sequence ▪ Enable Block 1 ▪ Enable Block 2 ▪ Unlocking 	Setting the action for scene recall
Dimming speed	0 ... 14400 s [1 s]	Setting the dimming speed for calling up scenes

Table 77: Settings – Scenes TW

The scenes can be called up using the following communication object:

Number	Name	Length	Usage
89 / 110	Scene	1 Byte	Call up of scenes

Table 78: Communication object – Scenes TW

The communication object for the scenes is only displayed if they are activated.

The following actions can be defined for calling up the scenes:

- **Deactivation**
The channel is switched off.
- **Activation value (Day/Night)**
The channel is set to the currently valid switch-on value (depending on whether it is day or night).
- **fixed CW/WW values**
A freely adjustable CW/WW value is controlled.
- **fixed TW values**
A freely adjustable Tunable White value is controlled.
- **TW – change color temperature**
Only the color temperature is set to a freely adjustable value. The brightness remains at its current value.
- **TW – change Brightness**
Only the brightness is set to a freely adjustable value. The color temperature remains at its current value.
- **Start sequence 1-2**
The respective sequence is started.
- **Start HCL**
HCL is started.
- **Stop sequence**
All active sequences are stopped.
- **Enable Block 1/2**
The block 1/2 is activated.
- **Unlocking**
The LED controller is unlocked.

To call up a scene or save a new value for the scene, the corresponding code is sent to the corresponding communication object for the scene:

Scene	Call		Save	
	Hex.	Dec.	Hex.	Hex.
1	0x00	0	0x80	128
2	0x01	1	0x81	129
3	0x02	2	0x82	130
4	0x03	3	0x83	131
5	0x04	4	0x84	132
6	0x05	5	0x85	133
7	0x06	6	0x86	134
8	0x07	7	0x87	135
9	0x08	8	0x88	136
10	0x09	9	0x89	137
11	0x0A	10	0x8A	138
12	0x0B	11	0x8B	139
13	0x0C	12	0x8C	140
14	0x0D	13	0x8D	141
15	0x0E	14	0x8E	142
16	0x0F	15	0x8F	143
17	0x10	16	0x90	144
18	0x11	17	0x91	145
19	0x12	18	0x92	146
20	0x13	19	0x93	147
21	0x14	20	0x94	148
22	0x15	21	0x95	149
23	0x16	22	0x96	150
24	0x17	23	0x97	151
25	0x18	24	0x98	152
26	0x19	25	0x99	153
27	0x1A	26	0x9A	154
28	0x1B	27	0x9B	155
29	0x1C	28	0x9C	156
30	0x1D	29	0x9D	157
31	0x1E	30	0x9E	158
32	0x1F	31	0x9F	159
....
64	0x3f	63	0xBF	191

Table 79: Command codes – Scene call up and saving

6.2.8 Tunable White Sequences

Two sequences can be set in Tunable White mode. The following picture shows the activation of the single sequences:

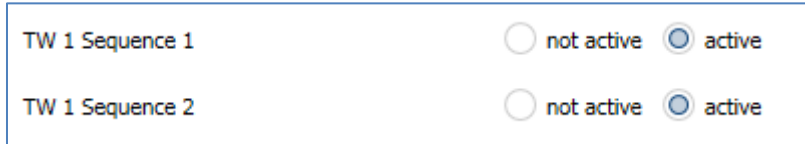

Figure 74: Settings – Activation of TW sequences

For each activated sequence, a submenu is displayed in which the corresponding sequence can be set.

In addition, a communication object for starting and stopping the sequence is displayed for each activated sequence:

Number	Name	Length	Usage
119	Start Sequence 1	1 Bit	1 = Start Sequence 1; 0 = Stop Sequence 1
120	Sequence 1 State	1 Bit	1 = Sequence is active; 0 = Sequence not active
121	Start Sequence 2	1 Bit	1 = Start Sequence 2; 0 = Stop Sequence 2
122	Sequence 2 State	1 Bit	1 = Sequence is active; 0 = Sequence not active

Table 80: Communication objects – TW sequences

The parameter "Send state during sequence" activates the status output during a sequence. This parameter can be found in the "Global settings" menu:

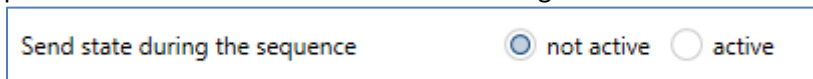

Figure 75: Setting – Send state during sequence

6.2.8.1 Sequences – General settings

The following settings are available for all types of sequences

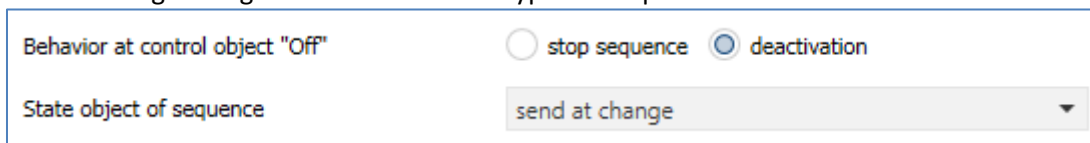

Figure 76: General settings – TW sequences

The following settings are available:

- Behaviour at control object „Off“**
 This parameter defines whether the Tunable White LEDs are switched off completely or only the sequence is stopped when the sequence is switched off.
- State object of sequence**
 This parameter defines the transmission behavior of the status object for the sequence. The setting "send on change" determines that the status is sent on each change. The setting "Send on change and restart" causes the status to be sent with each change and additionally after each run of a sequence.

6.2.8.2 Sequences via relative dimming

Action at brightness change via relative dimming	<input type="radio"/> sequence is stopped	<input checked="" type="radio"/> sequence is dimmed
Note: It can not be dimmed brighter than sequence values!		
Fallback time of brightness	no fallback ▾	
Behavior at control object "On"	<input checked="" type="radio"/> restore brightness change	<input type="radio"/> reset brightness change
Fallback of brightness at repeated "On"	<input type="radio"/> not active	<input checked="" type="radio"/> active

Figure 77: Sequences – Sequences via relative dimming

Sequences can also be dimmed down using relative dimming commands (setting: "Action on brightness change via relative dimming - sequence is dimmed"). It can only be dimmed down, but not above the set values. With relative dimming, the brightness values of the calibration points are then adjusted according to the dimming command: If, for example, dimming is reduced by 50%, all brightness values are reduced by 50% (30%→15%, 50%→25%, etc.). For relative dimming, there are several ways to reset the brightness change

- **Fallback time of brightness**
The brightness is automatically reset to the parameter value after a set time.
- **Behaviour at control object „On“**
The brightness can be restored with the dimmed value when the sequence is restarted via the "Restore brightness change" setting. The "Reset brightness change" setting resets the brightness to the set value from the parameters.
- **Fallback of brightness at repeated „On“**
The brightness is reset to the parameter value when two On commands are sent one after the other to the control object (start sequence).

If the parameter value is to be used for dimming upwards, the parameter "Keep HCL/sequences active" must be set to active. Now the channel can be dimmed upwards at any time and remains there until the next interpolation point is reached. From this point on, the channel synchronizes again with time-dependent dimming until the next interpolation point is reached.

6.2.8.3 Sequence settings

The following basic settings can be made::

Transition of sequence	<input checked="" type="radio"/> fixed transition period <input type="radio"/> times
Switch sequence with	<input checked="" type="radio"/> fixed values <input type="radio"/> random values
Endless loop	<input checked="" type="radio"/> not active <input type="radio"/> active
Number of execution	<input type="text" value="1"/>
Behavior after sequence	<input type="text" value="hold values"/>
Number of parameter steps	<input type="text" value="5"/>

Figure 78: Settings – TW sequences

The following table shows the possible settings:

ETS-Text	Dynamic range [Default value]	Comment
Transition of sequence	<ul style="list-style-type: none"> • Fixed transition period • Times 	Specifies whether the transition from one step to the next is to take place after a fixed time or at a specific time
Switch sequence with	<ul style="list-style-type: none"> • Fixed values • Random values 	The parameter specifies whether the colors for the individual steps are to be fixed or random values are to be generated. In addition, it is possible to switch the sequence according to fixed times
Random transition time	<ul style="list-style-type: none"> • not active • active 	Indicates whether the time between two steps should be random or should have a fixed value. Only available with Switch sequence with: Random values
Endless loop	<ul style="list-style-type: none"> • not active • active 	Defines whether the sequence is to run in an endless loop
Number of executions	1 ... 255 [1]	Only displayed if "endless loop" -> "not active". Parameter indicates the number of sequence executions.
Behaviour after sequence	<ul style="list-style-type: none"> • Deactivation • Hold values • Start sequence 1-2 	Only displayed if "endless loop" -> "not active". Parameter specifies the behavior after the current sequence has been executed.
Number of parameter steps	1 - 5 [5]	Defines the number of steps in this sequence

Table 81: Settings – TW sequences

Sequence with fixed values:

If the sequence is controlled with fixed values, certain values are entered for each step which are to be called in this step. The following figure shows the possible settings for the sequence with fixed values for TW control:

Step 1	
Color temperature	0% CW, 100% WW (warm +++)
Brightness	100%
Hold time	5 x100 ms
Transition time to the next step	10 s

Figure 79: Settings – Manual sequence with fixed values

As you can see in the picture above, a defined color temperature and a defined brightness can be approached for each step. The hold time indicates how long a step is to be executed or the sequence is to remain in this state.

The transition time defines the time in which from one step to the next should be dimmed.

Sequence with random values:

If the sequence is switched with random values, the values are generated randomly by the device. However, it is possible to limit the value ranges from which the random values are to be generated. The following figure shows the possible settings for the sequence with random values:

Lower limit Color temperature	0% CW, 100% WW (warm +++)
Upper limit Color temperature	100% CW, 0% WW (cold +++)
Lower limit Brightness	0%
Upper limit Brightness	100%
Hold time	5 x100 ms
Transition time to the next step	10 s

Figure 80: Settings – Manual sequence with random values

As shown in the picture above, the color temperature and brightness can be limited. The hold time indicates how long a step is to be executed or the sequence is to remain in this state.

Also the transition time can be changed between random or fixed value:

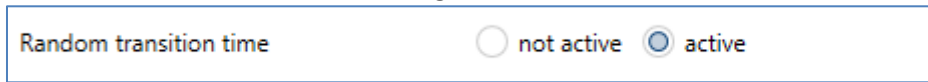

Figure 81: Setting – Random transition time

With a random transition time, the transition time can also be limited to a fixed value so that the dimming control unit selects a value between 0 and the parameterised value. The following parameter is displayed for random transition times:



Figure 82: Setting – Random time to next step

If the parameter "Random transition time" is set to inactive, a fixed value can be entered for the transition time.

The transition time defines the time in which the dimming should take place from one step to the next.

Numbers of loops

The number of loop passes can be defined with the following settings:

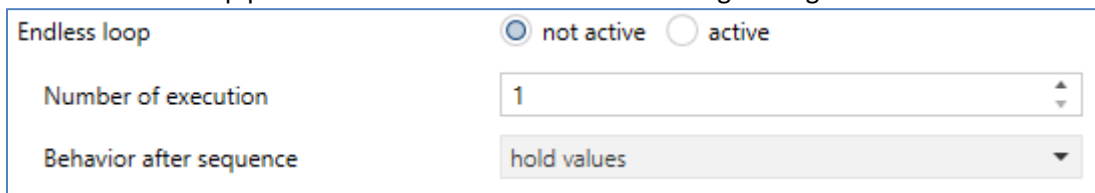

Figure 83: Settings – Number of endless loops

If the sequence is defined as an endless loop, the sequence is run through until it is stopped again via the communication object for this sequence. In this case, the other parameters for setting the loop passes are omitted.

If the sequence is not defined as an endless loop, the number of executions can be defined. In addition, a behavior can be defined after the end of the sequence. After the end of the sequence the Tunable White LED can be switched off or it can hold the last value. A following sequence can also be defined.

For example, sequence 1 can be followed by sequence 2. If this calls the first sequence again, an endless loop is created. Furthermore, this parameter can be used to extend a sequence by a maximum of 5 further steps

6.2.9 Human Centric Light (HCL)

Human Centric Light describes a time-controlled sequence that dynamically adapts the light color to the course of the day.

Human Centric Light is activated in the "LED Tunable White (TW 1/2)" menu:



Figure 84: Setting – Activation of Human Centric Light (HCL)

If HCL is activated, the submenu "LED TW Human Centric Light (HCL)" appears.

The following figure shows the possible settings:

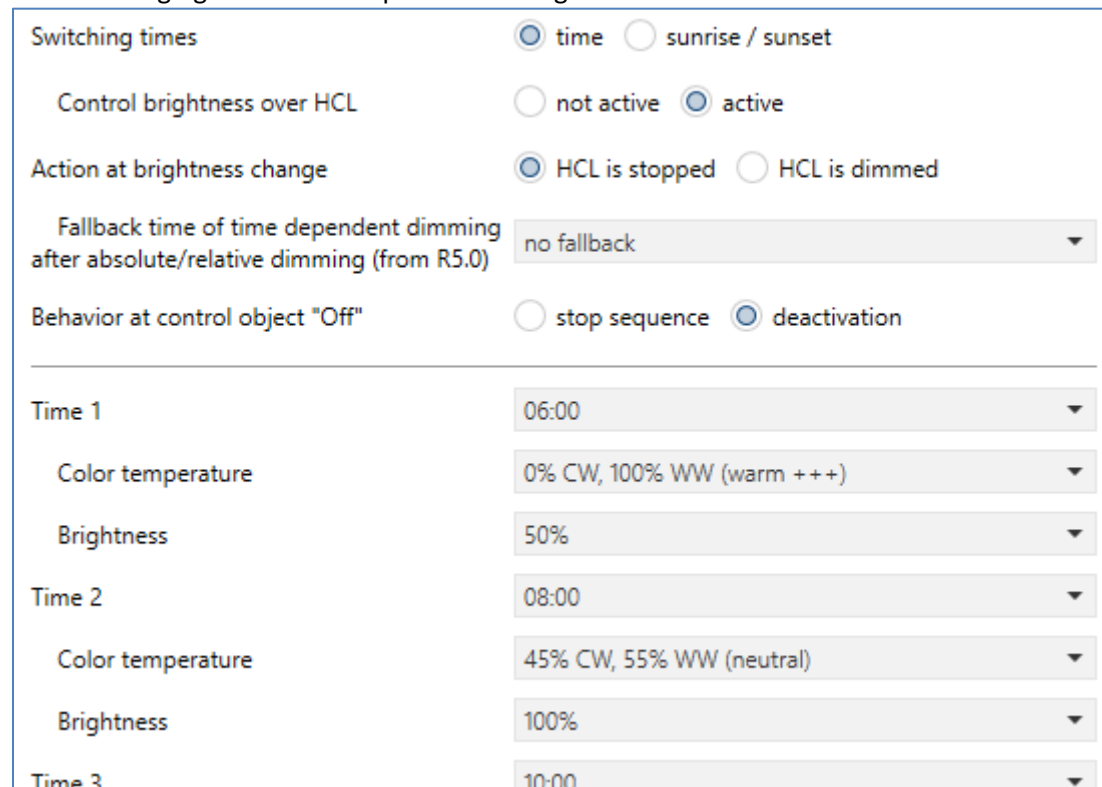

Figure 85: Settings – Human Centric Light (HCL)

The following settings are available for the Human Centric Light:

ETS-Text	Dynamic range [Default value]	Comment
Switching times	<ul style="list-style-type: none"> ▪ Time ▪ Sunrise / Sunset 	Setting whether to dim according to fixed times or sunrise/sunset times
Control brightness over HCL	<ul style="list-style-type: none"> ▪ not active ▪ active 	Setting whether fixed brightness values should also be specified for the calibration points
Action at brightness change via dimming	<ul style="list-style-type: none"> ▪ HCL is stopped ▪ HCL is dimmed 	Setting whether the brightness of the HCL can be changed via relative dimming commands or whether relative dimming commands terminate the HCL
Fallback time of brightness	<ul style="list-style-type: none"> ▪ no fallback ▪ 1 min – 12 h ▪ daily change (at 00:00) 	Setting the fallback time if the HCL was relatively dimmed. Only available if relative dimming has been enabled for HCL
Fallback time of time depending dimming after absolute/relative dimming (from R5.0)	<ul style="list-style-type: none"> ▪ No fallback ▪ 1 min – 12 h ▪ Daily change (at 00:00) 	Setting of the fallback time when abs. or rel. dimming. Only visible when "HCL is stopped". Only possible from R5.0!
Behaviour at control object „On“	<ul style="list-style-type: none"> ▪ restore brightness change ▪ reset brightness change 	Setting whether relative dimming is reset when switched back on. Only available if relative dimming has been enabled for HCL
Fallback of brightness at repeated „On“	<ul style="list-style-type: none"> ▪ not active ▪ active 	Setting whether relative dimming is reset on repeated "send on". Only available if relative dimming has been enabled for HCL
Behaviour at control object „Off“	<ul style="list-style-type: none"> ▪ Stop sequence ▪ Deactivation 	Setting whether Tunable White is switched off with the control object or only the sequence is stopped
Time 1-10	fixed time from 0-23 o'clock or time depending on sunrise/sunset	Setting the time for the respective base point. Depending on the "Switching times" parameter, fixed times or times depending on sunrise/sunset can be set here
Color temperature	<ul style="list-style-type: none"> • 0% CW, 100% WW • 5% CW, 95% WW • ... • 95% CW, 5% WW ▪ 100% CW, 0% WW 	Adjustment of the color temperature to be controlled for the respective base point
Brightness 1-10	0 – 100%	Adjustment of the brightness to be controlled for the respective base point

Table 82: Settings – Human Centric Light (HCL)

The Human Centric Light allows the colour temperature to be adjusted over the course of a day. Depending on the time of day, the channel adjusts the colour temperature and, if set, the brightness for these LEDs. The Human Centric Light can either be based on sunrise and sunset times (which the dimming actuator calculates itself) or on fixed times. For this purpose, 10 interpolation points (time + brightness value to be controlled) can be defined. The set colour temperature (and brightness) is then reached at the set time. The LED controller interpolates between the calibration points, i.e. if, for example, a colour temperature of 3000K is set for 8:00am and a colour temperature of 3500K is set for 10:00am, the channel will slowly dim the colour temperature from 3000K to 3500K within these 2 hours.

If the brightness is not controlled by HCL, it is for example possible to control the HCL by a constant light control

If the Human Centric Light is to be set to fixed brightness values, it is also possible to dim down the HCL using relative dimming commands (setting: "**Action on brightness change via relative dimming - HCL is dimmed**"). It can only be dimmed down, but not above the set values. With relative dimming, the brightness values of the calibration points are then adjusted according to the dimming command: If, for example, dimming is reduced by 50%, all brightness values are reduced by 50% (30%->15%, 50%->25%, etc.). For relative dimming, there are several ways to reset the brightness change:

- **Fallback time of brightness**
The brightness is automatically reset to the parameter value after a set time.
- **Behaviour at control object „On“**
The brightness is reset to the parameter value when an On command is sent to the control object (start sequence).
- **Fallback of brightness at repeated „On“**
The brightness is reset to the parameter value when two On commands are sent one after the other to the control object (start sequence).

If the parameter value is to be used for dimming upwards, the parameter "Keep HCL/sequences active" has to be set to active. Now the channel can be dimmed upwards at any time and remains there until the next interpolation point is reached. From this point on, the channel synchronizes again with time-dependent dimming until the next interpolation point is reached.

If the parameter "**Control brightness via HCL**" is set to inactive, HCL only controls the colour temperature and not the brightness. In this case, the brightness is kept constant at the start value and can be changed using relative dimming commands or absolute dimming commands.

The parameter "**Behavior at control object "Off"**" can ultimately be used to define whether Tunable White is switched off with the control object or only the sequence is stopped.

The following table shows the associated communication objects:

Number	Name	Length	Usage
123 / 131	LED TW 1/2 Human Centric Light (HCL) – Start HCL	1 Bit	Activating/deactivating the HCL
124 / 132	LED TW 1/2 Human Centric Light (HCL) – HCL State	1 Bit	Output of the status whether HCL is active or not

Table 83: Communication objects – Human Centric Light (HCL)

7 Index

7.1 List of Illustration

Figure 1: Structure – Hardware module MDRC	10
Figure 2: Structure – Hardware module flush mounted device.....	10
Figure 3: Exemplary circuit diagram, here AKD-0424V.02.....	11
Figure 4: Settings – Startup delay & operation	13
Figure 5: Global Settings – Day/Night object & Time/Date	14
Figure 6: Setting – Device selection MDRC.....	15
Figure 7: Settings – Function selection / Single channels.....	16
Figure 8: Global Settings – Further parameters	18
Figure 9: Settings – Channel activation.....	22
Figure 10: Settings – Switch On/Off delay	24
Figure 11: Functional diagram – Switch On/Off delay	24
Figure 12: Setting – Activation Staircase light.....	25
Figure 13: Settings – Staircase light function.....	25
Figure 14: Illustration – Staircase lighting process	26
Figure 15: Settings – Switch-on behaviour	27
Figure 16: Settings – Dimming Speed.....	29
Figure 17: Settings – Dimming Range	30
Figure 18: Settings – Send Status of dimming value	31
Figure 19: Setting – Dimming range under limit value.....	31
Figure 20: Setting – Switch off with relative dimming	32
Figure 21: Settings – Central objects.....	32
Figure 22: Settings – Block and Force functions	33
Figure 23: Setting – Activation Scene.....	37
Figure 24: Settings – Scenes	38
Figure 25: Settings – Bit scenes	41
Figure 26: Settings – Time dependent dimming	43
Figure 27: Settings – Function selection / Dimming RGB LED	46
Figure 28: Settings – Function selection / Dimming RGBW LED	46
Figure 29: Color Circle representation HSV	48
Figure 30: General settings – Dimming RGB/RGBW	49
Figure 31: Setting – Activation Single channel control	52
Figure 32: Setting –White balance via Teach-In.....	54
Figure 33: Settings – White balance via parameters	55
Figure 34: Settings – Status output.....	56
Figure 35: Settings – Activation Single-channel control.....	56
Figure 36: Settings – Dimming speeds.....	58
Figure 37: Settings – Switch on/off behaviour	59
Figure 38: Settings – Switch on/off behaviour 2.....	60
Figure 39: Setting – Behaviour after Reset	61
Figure 40: Settings – Staircase light.....	62
Figure 41: Settings – Block and Force functions (RGB/RGBW)	63
Figure 42: Settings – Bit Scenes (RGB/RGBW).....	67
Figure 43: Settings – Scenes (RGB/RGBW).....	70

Figure 44: Settings – Activation of sequences	74
Figure 45: General settings – Sequences (RGB/RGBW).....	75
Figure 46: Settings – Sequences via relative dimming.....	75
Figure 47: Setting – Activation of predefined sequences (RGB/RGBW).....	76
Figure 48: General settings – Manual sequences (RGBW/HSV).....	78
Figure 49: Settings – Manual sequence with fixed values	80
Figure 50: Settings – Manual sequence with random values	80
Figure 51: Setting – Random transition time	81
Figure 52: Setting – Random time to next step	81
Figure 53: Settings – Endless loop	81
Figure 54: Settings – Activatinon: Tunable White via RGBW	82
Figure 55: Settings – Tunable White via RGBW	82
Figure 56: Settings – Dim2Warm.....	86
Figure 57: Settings – Dim2Warm, Example 20%	88
Figure 58: Setting – Activation Human Centric Light (HCL) via RGBW	89
Figure 59: Settings – Human Centric Light (HCL) via RGBW	89
Figure 60: Settings – Function selection Tunable White	92
Figure 61: Global Settings – Tunable White.....	95
Figure 62: Settings – Switch On behaviour Tunable White	99
Figure 63: Settings – Staircase light.....	100
Figure 64: Settings – Dimming speed	101
Figure 65: Settings – Switch-on with relative dimming.....	102
Figure 66: Settings – Status output.....	102
Figure 67: Setting – Behaviour after Reset	103
Figure 68: Basic Settings – Tunable White.....	104
Figure 69: Settings – Dim2Warm (Brightness).....	107
Figure 70: Settings – Dim2Warm, Example 20%	109
Figure 71: Settings – Block and Force functions (Tunable White).....	110
Figure 72: Settings – Bit Scenes TW	114
Figure 73: Settings – Scenes TW	117
Figure 74: Settings – Activation of TW sequences	121
Figure 75: Setting – Send state during sequence.....	121
Figure 76: General settings – TW sequences	121
Figure 77: Sequences – Sequences via relative dimming.....	122
Figure 78: Settings – TW sequences	123
Figure 79: Settings – Manual sequence with fixed values	124
Figure 80: Settings – Manual sequence with random values	124
Figure 81: Setting – Random transition time	125
Figure 82: Setting – Random time to next step	125
Figure 83: Settings – Number of endless loops.....	125
Figure 84: Setting – Activation of Human Centric Light (HCL)	126
Figure 85: Settings – Human Centric Light (HCL).....	126

7.2 List of Tables

Table 1: Load distribution	9
Table 2: Communication objects – Alarms	13
Table 3: Communication object – Operation	13
Table 4: Communication objects – Day/Night & Time/Date	14
Table 5: Communication objects – Default settings single channels	17
Table 6: Global settings.....	20
Table 7: Communication objects – Relay as switching channel	21
Table 8: Communication objects – Relay request Master	21
Table 9: Communication objects – Relay request Slave	21
Table 10: Settings – Channel activation.....	22
Table 11: Communication objects – Switch.....	23
Table 12: Communication object – Dimming relative	23
Table 13: Communication object – Dimming absolute.....	23
Table 14: Settings – Switch On/Off delay.....	24
Table 15: Settings - Staircase light function.....	25
Table 16: Communication object – Staircase light.....	26
Table 17: Settings – Switch-on behaviour.....	27
Table 18: Settings – Dimming speed.....	29
Table 19: Settings – Dimming Range	30
Table 20: Settings – Send status of dimming value	31
Table 21: Communication object – State of dimming value	31
Table 22: Settings – Central objects.....	32
Table 23: Communications objects – Central objects	33
Table 24: Settings – Block and Force functions.....	35
Table 25: Communication objects – Locking functions.....	36
Table 26: Communication object – Scene.....	37
Table 27: Settings – Scenes.....	39
Table 28: Codes for calling and saving scenes.....	40
Table 29: Settings – Bit scenes.....	41
Table 30: Communication objects – Bit Scenes.....	42
Table 31: Settings – Time dependent dimming.....	44
Table 32: Communication objects – Time dependent dimming.....	45
Table 33: Communication objects – Default settings RGB/RGBW	47
Table 34: General settings – Dimming RGB/RGBW	50
Table 35: Communication objects – Relay as switch channel	51
Table 36: Communication objects – Relay request Master	51
Table 37: Communication objects – Relay request Slave	51
Table 38: Communication objects – HSV control.....	52
Table 39: Communication objects – RGB/RGBW control	52
Table 40: Communication objects – 3Byte color settings.....	53
Table 41: Communication object – White balance/Teach-In.....	54
Table 42: Communication objects – Status output RGB/RGBW.....	56
Table 43: Communication objects – Status output HSV	56
Table 44: Communication objects – Status Combination object	57
Table 45: Settings – Staircase light	62
Table 46: Communication object – Staircase light.....	62
Table 47: Settings – Block and Force functions (RGB/RGBW).....	65

Table 48: Communication objects – Block functions	66
Table 49: Settings – Bit Scenes (RGB/RGBW)	68
Table 50: Communication objects – Bit Scenes (RGB/RGBW)	69
Table 51: Settings – Scenes (RGB/RGBW)	71
Table 52: Communication object – Scenes (RGB/RGBW)	71
Table 53: Codes for calling and saving scenes	73
Table 54: Communication objects – Sequences (RGB/RGBW)	74
Table 55: General settings – Manual sequences (RGBW/HSV)	79
Table 56: Communication objects – Tunable White via RGBW	83
Table 57: Basic settings – Tunable White via RGBW	83
Table 58: Settings – Dim2Warm	87
Table 59: Settings – Human Centric Light (HCL) via RGBW	90
Table 60: Communication objects – Human Centric Light (HCL) via RGBW	91
Table 61: Standard settings and communication objects – Tunable White	94
Table 62: Global Settings – Tunable White	96
Table 63: Communication objects – Relais as Switch channel	96
Table 64: Communication objects – Relay request Master	97
Table 65: Communication objects – Relay request Slave	97
Table 66: Communication objects – Tunable White Control	98
Table 67: KNX Specification – DPT 249.600	98
Table 68: Settings – Staircase light	100
Table 69: Communication object – Staircase light	101
Table 70: Communication objects – Tunable White_Status Output	102
Table 71: Basic Settings – Tunable White	104
Table 72: Settings – Dim2Warm	108
Table 73: Settings – Block and Force Functions (Tunable White)	112
Table 74: Communication objects – Block functions Tunable White	113
Table 75: Settings – Bit scenes TW	115
Table 76: Communication objects – Bit Scenes TW	116
Table 77: Settings – Scenes TW	118
Table 78: Communication object – Scenes TW	118
Table 79: Command codes – Scene call up and saving	120
Table 80: Communication objects – TW sequences	121
Table 81: Settings – TW sequences	123
Table 82: Settings – Human Centric Light (HCL)	127
Table 83: Communication objects – Human Centric Light (HCL)	128

8 Attachment

8.1 Statutory requirements

The above-described devices must not be used with devices, which serve directly or indirectly the purpose of human, health- or lifesaving. Further the devices must not be used if their usage can occur danger for humans, animals or material assets.

Do not let the packaging lying around careless, plastic foil/ -bags etc. can be a dangerous toy for kids.

8.2 Disposal routine

Do not throw the waste equipment in the household rubbish. The device contains electrical devices, which must be disposed as electronic scrap. The casing contains of recyclable synthetic material.

8.3 Assemblage



Danger to life due to electric current!

The device may only be installed and connected by qualified electricians. Observe the country-specific regulations and the applicable KNX directives.

The devices are approved for operation in the EU and bear the CE mark. Use in the USA and Canada is not permitted.

After installation of the device and switching on the mains voltage, voltage may be present at the outputs. The outputs can be switched off via the built-in channel switch.

When the device is installed, a KNX bus telegram can switch the outputs to live at any time.

Before starting work on the device, always disconnect it from the power supply via the upstream fuses.

After installation, all live terminals and connections must be completely closed by the control panel cover to prevent accidental contact. It must not be possible to open the control panel cover without tools.

8.4 Revision history

V1.0	-	1 st Version of LED Controllers, Series .02	-	08/2019
V1.1	-	Extended by AKD-0424R2.02 (Manual was not released)		
V1.2	-	General corrections and adjustment to DB V2.4	-	01/2021